

TECHNICAL REPORT



Handbook on tuberculosis laboratory diagnostic methods in the European Union

Updated 2022

www.ecdc.europa.eu

ECDC TECHNICAL REPORT

Handbook on tuberculosis laboratory diagnostic methods in the European Union

Updated 2022



This report of the European Centre for Disease Prevention and Control (ECDC) was coordinated by Csaba Ködmön with support from Marieke J. van der Werf, Daniela Maria Cirillo, and Elisa Tagliani.

This report was sent for consultation to the members of ERLTB-Net (see Annex 3 for list of contributors).

The first version of this ECDC technical report, previously published as 'Mastering the basics of TB control: Development of a handbook on TB diagnostic methods' (Stockholm 2011), concerned the development of the handbook. This report was then revised and renamed 'Handbook on TB laboratory diagnostic methods in the European Union' in 2016, and subsequently in 2018 'Handbook on tuberculosis laboratory diagnostic methods in the European Union – Updated 2018'. As new scientific evidence became available, a further revision was undertaken in 2022, and four chapters were updated (chapters 6, 7, 8, and 10).

European Centre for Disease Prevention and Control. Handbook on tuberculosis laboratory diagnostic methods in the European Union – Updated 2022. Stockholm: ECDC; 2023.

Stockholm, September 2023

ISBN 978-92-9498-648-1

doi 10.2900/433652

Catalogue number TQ-07-23-359-EN-N

© European Centre for Disease Prevention and Control, 2023

Reproduction is authorised, provided the source is acknowledged.

Contents

Abbreviations	8
Background and introduction	10
How this handbook relates to other work available in this field.....	10
What this document is/is not.....	10
Intended use and users	11
History of the handbook	11
This edition	11
1 Biosafety in clinical laboratory diagnosis of TB	11
2 Quality assurance	11
3 TB infection.....	11
4 Smear microscopy.....	12
5 Culture for <i>Mycobacterium tuberculosis</i> complex.....	12
6 Molecular assays for rapid TB and drug-resistant TB detection	12
7 Phenotypic-based antimicrobial susceptibility testing for <i>Mycobacterium tuberculosis</i> complex	12
8 Molecular typing of <i>Mycobacterium tuberculosis</i> complex isolates.....	12
9 Use and validation of disinfectants for <i>Mycobacterium tuberculosis</i>	12
10 Information for physicians: the laboratory diagnosis of TB.....	12
Disclaimer	12
1 Biosafety in the laboratory diagnosis of TB	13
1.1 Background and principles.....	13
1.2 The containment laboratory (biosafety level 3).....	14
1.2.1 General considerations.....	14
1.3 Laboratory facility	15
1.4 Procedures.....	16
1.5 Personal protective equipment (PPE).....	16
1.6 The human resource component.....	17
1.7 Specific laboratory tasks related to hazards.....	17
References	19
Annex 1	20
2 Quality assurance.....	22
2.1 Background and principles.....	22
2.2 Selection and implementation of tests	24
2.3 Validation	24
2.4 Control and trend monitoring by key indicators.....	24
2.5 Physical and environmental conditions	25
2.6 Equipment	25
2.7 Management and staff	25
2.8 Documentation and registration	25
2.9 Sampling guidance, review of requests, and service to customers	26
2.10 Subcontracting, services, and supplies	26
2.11 Complaints, errors and corrective actions	26
2.12 Improvements	26
2.13 Reporting and releasing results	26
References	27
3 The diagnosis of TB infection	28
3.1 Background and principles.....	28
3.1.1 Immune response to <i>M. tuberculosis</i>	28
3.2 The tuberculin skin test (TST).....	29
3.3 Interferon- γ release assays (IGRAs)	30
3.3.1 Introduction.....	30
3.3.2 Current national guidelines and the clinical use of IGRAs.....	30
3.3.3 Predictive value of IGRA for progression to active TB	32
3.3.4 IGRA performance and reproducibility.....	32
3.3.5 Procedure 1: QuantiFERON-TB Gold and QuantiFERON-TB Gold PLUS	33
General principles	33
Baseline epidemiological data	33
Safety.....	33
Materials provided by the manufacturer.....	33
Required materials (not provided)	34
Storage.....	34

Methods	34
Report interpretation	35
Quality control	36
Quality control parameters	37
External quality assessment	37
3.3.6 Procedure 2: T-SPOT procedure	37
General principles	37
Baseline epidemiological data	37
Safety	37
Materials	38
Reporting	41
Quality control	41
External quality assessment (EQA)	41
References	42
Annex 2. Patient data sheet	44
4 Smear microscopy	45
4.1 Background and principles	45
4.2 Procedure 1: Ziehl-Neelsen (ZN)	45
4.2.1 Ziehl-Neelsen (ZN) reagent preparation	45
4.2.2 Storage of reagents	47
4.2.3 Quality control of freshly-prepared staining reagents	47
4.3 Procedure 2: Fluorochrome staining	47
4.3.1 Quality control of freshly-prepared staining reagents	47
Sample collection	48
Specimen handling	48
Criteria of acceptability	48
4.5 Smear preparation	49
4.6 Staining procedures	49
4.6.1 Ziehl-Neelsen staining method	49
4.6.2 Fluorochrome staining method	50
4.6.3 Automatic staining	50
4.7 Microscopy	50
4.7.1 Maintenance	51
4.7.2 Fluorescence microscopy	51
4.7.3 Light-emitting diode (LED) microscopy	51
4.8 Recording and reporting	51
4.8.1 ZN smear examination	52
4.8.2 Auramine (fluorochrome) smear examination	52
4.9 Quality control	53
4.9.1 Quality control parameters	53
References	54
5 Culture tests for <i>Mycobacterium tuberculosis</i> complex	55
5.1 Background and principles	55
5.2 Biohazards and biosafety in the TB laboratory	55
5.2.1 Minimum WHO recommendations for TB culture/drug susceptibility testing facilities	56
5.3 Specimen collection, storage and transport	57
5.3.1 Sample collection	57
5.3.2 Storage of specimens	58
5.3.3 Transportation of specimens	58
5.4 Homogenisation and decontamination of specimens	58
5.4.1 Digestion and decontamination of sputum samples	59
5.4.2 Digestion and decontamination of specimens other than sputum	61
5.5. Culture media: principles	62
5.6 Solid media	62
5.6.1 Egg-based media	62
5.6.2 Agar-based media	63
5.6.3 Liquid media	63
5.6.4 Quality control of media	63
5.7 Culture tube inoculation	64
5.7.1 Solid media	64
5.7.2 Liquid media	64
5.8 Culture incubation	64
5.9 Culture examination	64

5.10 Chromatographic immunoassay for the qualitative detection of <i>Mycobacterium tuberculosis</i> complex from cultures.....	66
5.10.1 Introduction.....	66
5.10.2 Materials.....	66
5.10.3 Methods.....	66
5.10.4 Results interpretation.....	66
5.10.5 Biosafety.....	66
References.....	68
6 Molecular assays for TB and drug-resistant TB rapid detection.....	69
6.1 Background and principles.....	69
6.2 Line probe assays.....	69
6.2.1 Line probe assays for <i>Mycobacterium</i> genus species identification.....	69
6.2.2 Line probe assays for identification of <i>M. tuberculosis</i> complex and drug resistance detection from pulmonary clinical specimens and cultivated samples.....	70
6.3 Real time PCR-based assays for the identification of <i>M. tuberculosis</i> complex and drug resistance detection.....	72
6.3.1 Single-use sample-processing cartridge system with integrated multicolour real-time PCR capacity for detection of <i>M. tuberculosis</i> complex and drug resistance detection.....	73
6.3.2 Chip-based real time micro-PCR for detection of <i>M. tuberculosis</i> complex and rifampicin resistance detection.....	74
6.3.3 Centralised assays for <i>M. tuberculosis</i> complex detection and detection of resistance to rifampicin and isoniazid.....	75
6.4 Next generation sequencing based approaches for drug-resistant tuberculosis detection.....	78
6.4.1 Whole genome sequencing.....	79
6.4.2 Targeted next generation sequencing.....	79
References.....	81
7 Phenotypic susceptibility testing to anti-tuberculous agents for <i>Mycobacterium tuberculosis</i> complex.....	84
7.1 Background and principles.....	84
7.2 General method – AST by culture.....	85
7.2.1 Definitions.....	85
7.2.2 Introduction.....	85
7.2.2 Materials.....	87
7.2.3 Methods.....	87
7.2.4 Report/interpretation.....	88
7.3 Proportion method on Löwenstein-Jensen medium.....	88
7.3.1 Introduction.....	88
7.3.2 Materials.....	88
7.3.3 Methods.....	88
7.3.4 Report interpretation.....	90
7.4 Drug susceptibility testing in liquid media (Bactec MGIT 960).....	90
7.4.1 Introduction.....	90
7.4.2 Materials.....	90
7.4.3 Methods.....	90
7.4.4 Report interpretation.....	91
7.5 Minimum Inhibitory Concentration (MIC) determination following the EUCAST reference method.....	92
References.....	94
8 Molecular typing of <i>Mycobacterium tuberculosis</i> complex isolates.....	97
8.1 Background and principles.....	97
8.2 IS6110 RFLP typing.....	97
8.3 Spoligotyping.....	98
8.4 MIRU-VNTR typing.....	98
8.5 Whole genome sequencing.....	99
8.6 Targeted NGS.....	100
8.7 General considerations on genotyping methods.....	100
8.8 Materials.....	101
8.9 Results/interpretation.....	102
8.10 Quality control.....	102
References.....	103
9 Use and validation of disinfectants for <i>Mycobacterium tuberculosis</i>	106
9.1 Liquid disinfection.....	106
9.1.2 Carrier Test: EN 14563:2008.....	107
9.1.3 Choice of method to be used.....	108

9.2 Gaseous disinfection	108
9.2.1 Vaporised hydrogen peroxide and hydrogen peroxide vapour	108
9.2.2 Dry mist hydrogen peroxide	109
9.2.3 Plasma hydrogen peroxide	109
9.2.4 Use of gaseous disinfection in accident scenarios	109
References	111
10 Information for physicians: laboratory diagnosis of TB	112
10.1 Introduction	112
10.2 General considerations regarding the diagnosis of TB	113
10.3 Specific considerations regarding diagnosis of TB.....	114
10.3.1 Pulmonary material.....	114
10.3.2 Extrapulmonary material	115
10.3.3 Pleural material	115
10.3.4 Lymphadenitis material	115
10.3.5 Peritoneal fluid	116
10.3.6 Urine.....	116
10.3.7 Blood	116
10.4 Information flow from microbiologist to physician and instructions regarding TB diagnosis	116
References	119
Annex 3. Network partners	120

Figures

Figure 1. Biohazard warning sign for laboratory doors	14
Figure 2. Potential outcomes of human host infection by <i>M. tuberculosis</i>	29
Figure 3. Microscope components.....	50
Figure 4. AFB smear microscopy of biological specimens	52
Figure 5. AFB smear microscopy of <i>M. tuberculosis</i> cultures.....	52
Figure 6. Minimal examination schedule for solid cultures	65
Figure 7. Examples of chromatographic immunoassays for qualitative detection of <i>M. tuberculosis</i> complex	67
Figure 8. Interpretation sheet for GenoType cMdirect assay.....	70
Figure 9. Configuration of GenoType MTBDRplus V2 (a) and GenoType MTBDRsl V2 (b) strips.....	72
Figure 10. BD MAX system at the National Research Center, Borstel, Germany	77
Figure 11. FluoroCycler XT at the Ospedale San Raffaele TB Supranational Reference laboratory, Milan, Italy	78
Figure 12. Deeplex-MycTB Workflow.....	80
Figure 13. Scheme of the microtitre plate for the EUCAST AMST broth microdilution reference protocol.....	93
Figure 14. Example of reporting form for NGS-based testing (drug resistance profile and cluster analysis)	118

Tables

Table 1. Examples of personal protective equipment	17
Table 2. Overall scope of ISO 17025 and ISO 15189	23
Table 3. Central terms and abbreviations in quality assurance.....	23
Table 4. List of national TB infection diagnosis guidelines	31
Table 5. QuantiFERON-TB Gold results interpretation	36
Table 6. QuantiFERON-TB Gold PLUS results interpretation.....	36
Table 7. Materials provided by the manufacturer	38
Table 8. Equipment required for smear preparation and staining	49
Table 9. Reporting of microscopy smears	51
Table 10. Common causes of error in smear microscopy.....	53
Table 11. Types and specifics of LPAs used for detection and differentiation of <i>Mycobacteria</i>	69
Table 12. Genes, codon regions and nucleotide sequences targeted by the Xpert MTB/XDR test	74
Table 13. Diagnostic accuracy of Truenat MTB, MTB Plus and MTB-RIF Dx tests relative to culture, in microscopy centre settings (derived by FIND evaluation study)[18]	75
Table 14. Critical concentrations for isoniazid and the rifamycins [13].....	86
Table 15. Critical concentrations and clinical breakpoints for medicines recommended for the treatment of RR/MDR-TB [24].....	87
Table 16. Solvents and diluents.....	89
Table 17. Second line drugs solvents, diluents and concentrations for AST in MGIT	91
Table 18. Differences between the two major gaseous hydrogen peroxide technologies, Steris VHP and Bioquell HPV	109
Table 19. Key differences between WGS and targeted NGS strategies.....	117

Abbreviations

AFB	Acid-fast bacilli
AMR	antimicrobial resistance
AST	antimicrobial susceptibility testing
BCG	Bacillus Calmette-Guérin
BD	Becton and Dickinson
BSL	Biosafety level
CFU	Colony-forming units
CLSI	Clinical and Laboratory Standards Institute
CSF	Cerebral spinal fluid
CRI	Colorimetric redox indicator
CXR	Chest X-ray
DNA	Deoxyribonucleic acid
DST	Drug susceptibility testing
ECOFF	Epidemiological cut-off value
EEA	European Economic Area
EMA	European Medicines Agency
ENP	European Neighbourhood Policy
EPTB	Extrapulmonary tuberculosis
ERLN-TB	European Reference Laboratory Network for Tuberculosis (2010–2014)
ERLTB-Net	European Reference Laboratory Network for Tuberculosis (from 2014)
ERLTB-Net2	European Reference Laboratory Network for Tuberculosis (from 2018)
EQA	External quality assessment
EU	European Union
EUCAST	European Committee on Antimicrobial Susceptibility Testing
GC	Growth control
HEPA filter	High-efficiency particulate air filter
HPF	High-power field
IATA	International Air Transport Association
IFN- γ	Interferon-gamma
INSTAND e.V.	Society for promoting quality assurance in medical laboratories
IGRA	Interferon-gamma release assay
IQA	Internal quality assessment
ISO	International Organization for Standardization
LED	Light-emitting diode
LJ medium	Löwenstein-Jensen medium
LTBI	Latent TB infection
MGIT	Mycobacteria growth indicator tube
MIC	Minimum inhibitory concentration
MIRU	Mycobacterial interspersed repetitive units
MODS	Microscopically observed drug susceptibility
MTBC	<i>Mycobacterium tuberculosis</i> complex
NAAT	Nucleic-acid amplification test
NGS	Next generation sequencing
NRA	Nitrate reductase assay
NRL	National reference laboratory
NTM	Non-tuberculous mycobacteria
PBMC	Peripheral blood mononuclear cells
PCR	Polymerase chain reaction
PPD	Purified protein derivative
PPE	Personal protective equipment
PPV	Positive predictive value
pWT	Phenotypically wild-type
QC	Quality control
RFLP	Restriction fragment length polymorphism
RNI	Reactive nitrogen intermediates

RRDR	Rifampicin resistance-determining region
SDS	Sodium dodecyl sulfate
SNP	Single nucleotide polymorphism
SOP	Standard operating procedures
SS+	Sputum smear positive
SS-	Sputum smear negative
TB	Tuberculosis
TLA	Thin Layer Agar
TST	Tuberculin skin test
UKAS	United Kingdom Accreditation Service
UK NEQAS	UKAS-accredited proficiency testing provider No. 4715
VNTR	Variable number tandem repeat
WGS	Whole genome sequencing
WHO	World Health Organization
WRD	WHO-recommended rapid diagnostics
ZN	Ziehl-Neelsen (staining method)

Background and introduction

Tuberculosis (TB) is a major cause of morbidity and mortality in Europe. High-quality laboratory diagnosis of TB is the basis for both individual patient treatment and surveillance.

In 2007, a survey of existing mycobacterial laboratory services and quality control practices throughout the European Union (EU) confirmed the key role of national reference laboratories (NRL) for TB and their services. The main conclusion of the survey was that a network of reference laboratories for TB could contribute to improving the performance of mycobacterial laboratories in Europe.

Based on these results, the European Reference Laboratory Network for Tuberculosis (ERLN-TB) was launched in January 2010 with the aim of strengthening TB diagnostics in the EU. ERLN-TB was funded and coordinated by ECDC. One or two officially nominated reference laboratories from each EU Member State joined the network, along with those in European Economic Area (EEA) and EU candidate countries.

Following the success of the ERLN-TB network, in 2014, 2018, and 2022 ECDC commissioned a renewal of the network (called the European Reference Laboratory Network for Tuberculosis, ERLTB-Net, ERLTB-Net-2, and ERLTB-Net-3 respectively) involving the same centres but anticipating the participation of institutions from the EU enlargement countries in the longer term.

The three main goals of the new network are: to support the harmonisation of laboratory methods within the EU/EEA; to develop External Quality Assurance (EQA) schemes; and to provide training activities within the network to ensure EU-wide capacity-building for TB diagnostics. One of the main activities conducted by the network was the development of a handbook of key diagnostic methods for TB, which was first published in 2011. It underwent updating in 2014 and 2018, as new scientific evidence became available, and this document represents the latest version, updated in 2022.

The aim of this handbook is to provide network members and other laboratories involved in the diagnosis of TB with an agreed list of key diagnostic methods, ranging from microbiological diagnosis of active TB to the diagnosis of TB infection. This handbook offers a single source of reference by compiling all methods, with a strong focus on standard (reference) and evidence-based methods.

The handbook will also contribute to the improvement of disease surveillance data for Europe: data sent to ECDC's EpiPulse (The European surveillance portal for infectious diseases) and other surveillance systems should be robust and backed by quality laboratory diagnostics.

This edition of the handbook addresses the changing technological landscape that has emerged over the last decade, particularly with regard to molecular-based assays and genome sequencing. Much of this technology has led to a major shift in TB diagnostic activities with the development of multiple, large, and well-equipped diagnostic centres with similar capacity and skills to national reference laboratories (e.g. rapid molecular diagnostic tests, WGS, NGS). Conversely, other molecular diagnostic developments have moved us away from 'big laboratory' approaches and closer to 'point-of-care' devices. The two approaches are not mutually exclusive, and both bring advanced diagnostics closer to the patient. The handbook is designed to meet the needs of both centralised and decentralised service delivery models and recognises that the role of national reference laboratories will change significantly over the next few years.

How this handbook relates to other work available in this field

This handbook presents a compilation of methods currently applied in EU/EEA Member States. It describes common work carried out and endorsed by European laboratory experts. It also features methods and procedures developed or refined by ERLTB-Net network partners.

What this document is/is not

This document is a handbook of agreed methods in the field of TB diagnostics for laboratories serving reference functions in Europe. It provides a comprehensive compilation of key methods for the diagnosis of TB. Relevant stakeholders are encouraged to use this compilation as a basis for the validation, development, updating and dissemination of information.

The current document does not contain any formal recommendations for implementation of specific methods in EU/EEA Member States. Recommendations and protocols contained within the handbook are not mandatory for EU/EEA laboratories.

Intended use and users

This handbook, which provides both basic- and reference-level methods for the diagnosis of TB, is intended for use by laboratory experts. It will also be of interest to public health professionals in the field of global TB control, particularly those involved in European initiatives to foster progress towards the elimination of TB.

History of the handbook

The first annual meeting of the ERLN-TB was held in Stockholm in 2010. During this meeting, the network partners came to a consensus agreement about the relevant topics to be included in a handbook on (reference) laboratory methods for the diagnosis of TB. The approach was to include several standardised and reliable methods, rather than to focus on one single method. A dedicated writing committee was formed to compile the first draft of these methods, using a handbook format. Each chapter includes descriptions of standardised diagnostic methods and highlights key considerations regarding operational characteristics, biosafety, and quality assurance (QA).

The first edition was published in 2011. The handbook was extensively revised during 2014–2015 following the formation of the new ERLTB-Net network and a new version titled 'Handbook on TB laboratory diagnostic methods in the European Union' was published in 2016. The handbook was further revised in 2018, with changes to Chapters 6.7 and 10.4 as new scientific evidence become available. More recently, based on the discussion made during the Network Annual meeting in January 2021, it was agreed on the need of updating the handbook to capture the expanding landscape of molecular diagnostics recommended by the World Health Organization (WHO) and new developments in this field based on the use of next generation sequencing (NGS) technology as an accurate method for *Mycobacterium tuberculosis* (MTB) drug resistance prediction (Chapter 6), as well as the use of NGS methods for MTB typing and relatedness analysis (Chapter 8). In addition, following on the revised critical concentrations of several anti-TB medicine, and the publication of a reference method for testing of minimum inhibitory concentrations (MIC) by EUCAST, an updated version of Chapter 7 on phenotypic drug susceptibility testing was deemed necessary. Lastly, in light of this dynamic scenario, Chapter 10 was updated to provide examples of best practices on how to maximise the contribution of the laboratory in the diagnostic process.

This edition

This handbook represents the fourth edition of a publication on the most reliable TB diagnostic methods, endorsed by the members of the ERLTB-Net. This publication is a compilation of methods for the laboratory diagnosis of TB, designed for laboratory experts and public health professionals. It was compiled to contribute to the harmonisation of methods in the field of TB diagnosis in the EU/EEA, EU enlargement countries and European Neighbourhood Policy (ENP) partner countries, with the goal of ensuring comparability of TB diagnoses in Europe, and provision of the best care possible for TB patients, based on a quality-assured diagnosis. This publication can also support laboratories in establishing a safe working environment for staff by minimising the risk of exposure to *M. tuberculosis*. The third edition of the ERLTB-Net handbook consists of 10 chapters, each with a list of relevant references. Below is a summary of each chapter.

1 Biosafety in clinical laboratory diagnosis of TB

M. tuberculosis can cause laboratory-acquired infections. To ensure effective infection control, it is crucial that a comprehensive and strict biosafety policy is developed and followed. Such a policy includes standardised rules and regulations for containment, personal protective equipment (PPE), standard operating procedures (SOP) for different laboratory tasks, and a transparent structure for regulating safe working conditions in diagnostic TB laboratories.

2 Quality assurance

National TB programmes are supported by laboratories that provide reliable and quality-assured results. The chapter provides a comprehensive overview of existing International Organization for Standardization (ISO) standards relevant for the laboratory diagnosis of TB and describes internal and external quality assurance (QA) procedures.

3 TB infection

Two types of tests are currently used for the diagnosis of TB infection: tuberculin skin tests (TSTs) and Interferon-gamma release assays (IGRAs). The chapter describes in detail the two most commonly used IGRAs for the detection of TB infection and provides support for interpreting and reporting test results.

4 Smear microscopy

Two types of staining are most commonly used for the detection of mycobacteria: carbol-fuchsin staining (Ziehl-Neelsen, Kinyoun) and fluorochrome staining (auramine, auramine-rhodamine). The chapter describes the preparation of the required reagents and the sputum smear samples, as well as the staining procedures and the system for reporting results.

5 Culture for *Mycobacterium tuberculosis* complex

The use of cultures improves the sensitivity and specificity of TB tests, particularly at the early stages of the disease, in cases of extrapulmonary tuberculosis (EPTB) and in the event of treatment failure. The chapter provides an overview of key principles for sampling and transporting clinical specimens and processing sputum and other specimens before inoculation to solid and liquid culture media, culture incubation and examination. The issue of contamination is addressed, along with the measures necessary to prevent laboratory-acquired TB infections.

6 Molecular assays for rapid TB and drug-resistant TB detection

Molecular assays can speed up mycobacterium identification and drug susceptibility testing, and thus lead to faster and more specific treatment. This chapter provides an overview of the most commonly used molecular diagnostics for the rapid detection of TB and drug-resistant TB from culture and clinical specimens. In addition, it includes a description of the current applications of next generation sequencing (NGS) for drug susceptibility and resistance prediction starting from clinical specimens (i.e. targeted NGS) and culture isolates (i.e. whole genome sequencing).

7 Phenotypic-based antimicrobial susceptibility testing for *Mycobacterium tuberculosis* complex

The main objectives of phenotypic-based antimicrobial susceptibility testing are to improve individual treatment management of TB cases and drug-resistance surveillance at the level of a hospital, city, region, or country. The chapter describes the methods for phenotypic antimicrobial susceptibility testing (AST) for *Mycobacterium tuberculosis* and other members of the *M. tuberculosis* complex (MTBC), as well as the EUCAST reference method for minimum inhibitory concentration (MIC) determination.

8 Molecular typing of *Mycobacterium tuberculosis* complex isolates

Various DNA fingerprinting methods are currently available that serve different purposes and have variable characteristics for specific applications. This chapter briefly describes the three traditional DNA fingerprinting methods: spoligotyping, variable number tandem repeat [VNTR] typing, IS6110 restriction fragment length polymorphism [RFLP] typing, while providing a more extensive description of the newest typing methodologies relying on the next generation sequencing (NGS) technology.

9 Use and validation of disinfectants for *Mycobacterium tuberculosis*

In Containment Level 3 laboratories handling *M. tuberculosis*, liquid and gaseous methods are currently in use for disinfection and decontamination. The efficacy of any new disinfectants is analysed using a set of standard validation methods.

10 Information for physicians: the laboratory diagnosis of TB

The process of collecting material for the diagnosis of mycobacteria requires great care, as each step can influence the diagnosis. This chapter aims to discuss how the information generated in the laboratory should be shared with clinicians and how to maximise the contribution of the laboratory in the diagnostic process.

Disclaimer

Some protocols included in the handbook list specific commercial products and assays. Such instances do not constitute endorsement of relevant products by ECDC.

1 Biosafety in the laboratory diagnosis of TB

Maryse Fauville-Dufaux, Vincent Jarlier, Dick van Soolingen, Sven Hoffner

Revised by Dick van Soolingen, Dimitrios Papaventsis, Melles Haile, and Sven Hoffner (2014)

Note: This chapter largely consists of a summary of principles and procedures previously published by the World Health Organisation [1]. It focuses on aspects relevant to the infrastructure of European diagnostic laboratories for TB. For a more comprehensive view, please refer to the publications listed at the end of this chapter.

1.1 Background and principles

Mycobacterium tuberculosis, the causative agent of TB, is classified as a risk group 3 agent, which calls for a Biosafety Level 3 laboratory (BSL3) for culture, drug susceptibility testing and other laboratory examinations. Access to a safety laboratory should be restricted to staff members and accredited visitors [1]. This chapter describes the most important features of the facility, the procedures, and the personal protective equipment required to ensure biosafety.

It is well documented that *M. tuberculosis* can cause laboratory-acquired infections and the risk of TB among healthcare workers is consistently higher than the risk in the general population [2]. *M. tuberculosis* even features in the top-ten list of hazardous agents for laboratory staff, however the source of the TB infection can only be traced to a specific laboratory accident in a minority of cases [3-5]. The most significant route for laboratory-acquired infections is aerosols. Thus, infection control efforts need to focus on limiting the generation of aerosols during laboratory work, for example through safe centrifugation and pipetting. The potential risk of infection depends on the type of techniques used and the way they are executed. For example, needle stick injuries are rare as in most laboratories the BD Bactec 460 system has been replaced by the µGIT 960 system, which does not use needles for the inoculation of test vials. Moreover, improvements in quality as a result of regular validation and proper use of biosafety cabinets have significantly enhanced infection control.

For effective infection control it is crucial that a comprehensive and strict biosafety policy is developed, accepted and followed by the laboratory staff. The policy should include standardised rules and regulations for containment; personal protective equipment (PPE); a set of standard operating procedures (SOPs) for all the different laboratory tasks and transparent and clearly defined levels of responsibility for establishing and maintaining safe working conditions in the diagnostic TB laboratory [1,3,6,7]. In addition to the necessary training, there should be regular interaction between the responsible manager and the laboratory staff on interpretation of the rules and potential biosafety hazard to verify commitment and optimise follow-up of the implemented procedures.

In the 2012 version of the WHO manual on biosafety in TB laboratories [8], more emphasis was placed on risk assessment. The risk of laboratory infections due to *M. tuberculosis* is related to the concentration of bacteria and the possible induction of aerosols. The handling of clinical specimens such as sputum (e.g. for smear examination and culture inoculation) poses a lower biohazard than working with positive cultures of the bacteria (e.g. for drug susceptibility testing). Therefore, sputum smear microscopy, treatment of specimens before culture, and DNA extraction from clinical specimens for molecular techniques (DNA identification, detection of gene mutations related to drug resistance or possible genotyping) may be carried out in a BSL2 laboratory setting. Nevertheless, the use of a well-functioning and regularly serviced biosafety cabinet remains important when working with suspected *M. tuberculosis* material. Techniques performed on *Mycobacterium* cultures, such as the extraction of DNA from positive cultures and phenotypic drug susceptibility testing, require a higher level of biosafety and the use of a BSL3 containment laboratory. Molecular techniques involving previously extracted DNA do not require a biosafety level standard [1,3,6].

Before initiating a new test, task, or method in a laboratory, a risk assessment is obligatory. This will identify possible risks and allow for proper infection control measurements. In 2008, the European Committee for Standardization (CEN) published the CWA 15793 Laboratory Biorisk Management Standard, which is based on a management systems approach [9]. Both CWA 15793:2008 and its latest version CWA 15793:2011 are laboratory biorisk management system agreements, establishing the requirements necessary to control risks associated with the handling or storage and disposal of biological agents and toxins in laboratories and facilities [10,11]. These standards use risk classifications described in the WHO laboratory biosafety manual and formed the basis for development of the minimum requirements for TB diagnostic laboratories, described in the 2012 edition of the WHO Tuberculosis Laboratory biosafety manual [8].

Appropriate infection control measures are necessary to enable laboratory staff to work safely with potentially infectious microorganisms. These measures are based on the following four main components:

- administration (management);
- environment (engineering);
- personal protective equipment (PPE);
- technical expertise and training (good microbiological practices).

If correctly implemented, each of these components will help lower the risk of exposing laboratory personnel to the pathogen.

A scheme for biosafety training and registration of laboratory staff experience levels is a useful tool for reducing the risk of laboratory infections. New staff members and regular laboratory staff should periodically undergo medical examination to document any laboratory-acquired infections and to offer preventive therapy or full treatment according to national guidelines. This will also make it possible to improve procedures that may have contributed to the LAI and will ensure that management and staff continue to focus on biosafety.

The biosafety policy and guidelines should be based on national and international regulations, as well the specific local risk assessment for each stage of clinical diagnostic work. Since international recommendations might change over time and are often not very detailed, it is of great importance to always base new biosafety instructions on the most recent sources and to implement a regular update of the biosafety policy [1,6].

This chapter is based on available biosafety recommendations at the time of writing (September 2013), and should not be seen as a replacement of other international recommendations. The recently released WHO TB laboratory biosafety manual [8] differs in its approach by putting less emphasis on each and every detail of a fully established BSL3 laboratory, and emphasising the importance of risk assessment in relation to the work conducted by TB laboratories at different levels. ECDC has also worked with an expert group of biosafety professionals [12] on a risk-based approach analysing work practices in TB laboratories in Europe, and in 2013 it produced important recommendations for the ERLN-TB [12,13]. This chapter reflects the views of the authors and does not imply an endorsement by ECDC.

1.2 The containment laboratory (biosafety level 3)

1.2.1 General considerations

The international biohazard warning symbol and other relevant signs displayed on laboratory access doors must identify the biosafety level and the name of the laboratory supervisor controlling access (Figure 1). Signs should also indicate the conditions for access, for example use of respirators and immunisation requirements. The best way to control access and also enable a retrospective check-up of all staff that entered the BSL3 laboratory at a particular point in time, is to use an electronic pass system. Any maintenance or technical personnel should always be accompanied by an authorised staff member and only be allowed access when the laboratory is considered relatively safe and if they are wearing personal protective equipment and the appropriate gown and shoes [1].

Figure 1. Biohazard warning sign for laboratory doors

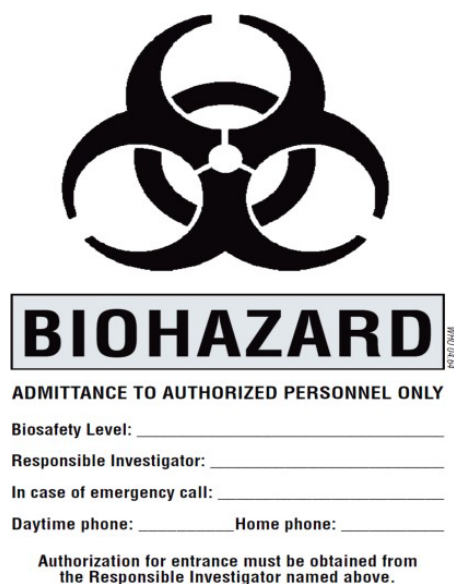

Source: World Health Organization. *Laboratory biosafety manual, 3rd edition. Geneva; 2004 [1].*

Inside the laboratory, protective clothing and shoes are used in accordance with local regulations. It is recommended that non-permeable/waterproof laboratory coats be used, either with a solid front or a wrap-around cut. Where appropriate, shoe covers (overshoes) or dedicated shoes should be worn. Front-buttoned standard laboratory coats are unsuitable, as are sleeves that do not fully cover the forearms. When working in the biosafety cabinet, the cuffs of the gown should be covered by disposable gloves to prevent contamination of the sleeves.

Laboratory protective clothing should never be worn outside the laboratory and should be decontaminated before being laundered. Potentially infectious material should always be handled in a biological safety cabinet (corresponding to specific standards – e.g. BS EN 12469:2000 or NSF/ANSI 49-2008). Respiratory protective equipment is necessary for some laboratory procedures [1].

1.3 Laboratory facility

There are many technical aspects to be considered before a BSL2 or BSL3 facility is constructed. Planning includes choice of equipment, ventilation system, technical maintenance, and waste management, including the placing of the autoclave. All details of the construction should be documented and strictly follow the relevant rules and regulations at national level. If no national rules have been established, application of international rules is advised. The choice between BSL2 and BSL3 or a combination of BSL2 and BSL3 zones in the same facility is based on European and national regulations and is dependent on a risk assessment of the type of work to be carried out in the facility.

The laboratory should be separated from areas that offer unrestricted entrance to the building. If the laboratory cannot be located in a separate, dedicated building, separation may be achieved by placing the laboratory at the blind end of a corridor, or by constructing a partition and a door or only allowing access through an anteroom. The anteroom should have clearly demarcated zones, with facilities for separating clean and dirty clothing and a shower. The anteroom doors should be self-closing and should open/close in the right direction to facilitate differences in pressure. The doors should also be interlocked, so that only one door can be open at a time. Ideally, there should be an electronic delay system that only allows the opening of one of the doors when the pressure in the anteroom has been restored. Depending on its size and shape the laboratory should have a break-through panel or emergency exit for use in case of emergencies [1,3].

As a rule, the following issues should be taken into consideration [1,3]:

- Ample space should be provided around the equipment for cleaning and maintenance.
- Walls, ceilings and floors should be non-absorbent, easy-to-clean, impermeable to liquids and resistant to the chemicals and disinfectants normally used in the laboratory. Floors should be slip resistant.
- Openings through these surfaces (e.g. for service pipes) should be sealed to prevent leakage and facilitate decontamination of the room/s using gas.
- Bench tops should be impervious to water and resistant to disinfectants, acids, bases, organic solvents and moderate heat.
- Lighting should be adequate for all activities. Undesirable reflections and glare should be avoided.
- Laboratory furniture should be sturdy.
- Open spaces between and under benches, cabinets and equipment should be accessible for cleaning.
- Windows should be sealed and break-resistant.
- Storage space must be adequate to hold supplies for immediate use and thus prevent clutter on bench tops and in aisles. Additional long-term storage space, conveniently located outside the laboratory working areas, should also be provided for storage of samples, cultures, records and for designated laboratory waste prior to autoclaving.
- A hand-washing station with hands-free controls should be provided near the exit door.
- To contain unintended release of aerosols, a controlled ventilation system should continuously maintain the negative pressure. A visual monitoring device should be placed at the entrance and in the inside of the laboratory to enable the pressure to be checked.
- There should be an alarm to warn personnel when pressure is out of range without causing panic or undesirable reactions.
- The building ventilation system should be installed in such a way that air from the containment laboratory can never be recirculated to other sections of the building.
- Air from the BSL3 laboratory should be filtered by HEPA filters. When air extracted from the laboratory is discharged to the outside of the building, it must be dispersed away from occupied buildings and air intakes. A heating, ventilation and air-conditioning control system may be installed to prevent positive pressurisation of the laboratory.
- The HEPA filters must be installed in a manner that permits gaseous decontamination and testing. The exhausted air from biological safety cabinets, which will have been passed through HEPA filters, should be discharged so that it does not interfere with the air balance in the laboratory.
- Biological safety cabinets should be situated away from walking areas and cross-currents from doors and ventilation systems.

- There should be a programme in place for the regular testing and validation of biological safety cabinets.
- An autoclave for the decontamination of contaminated waste material should be available in the containment laboratory, ideally in the wall. In this way containers with contaminated waste can be uploaded in the BSL3 laboratory and, after the autoclave procedure, safely removed in a clean zone outside of the laboratory. In accordance with local regulations in some countries, the autoclave may be connected to the laboratory, located in the same building. In this case infectious waste must be transported in sealed, unbreakable and leak-proof containers in accordance with national or international regulations, as appropriate. These containers should preferably have vents that open when the containers are heated, so the steam can exit the containers.
- Waste water coming from the sinks installed in BSL3 should be decontaminated in kill tanks. Otherwise, if decontamination facilities are not available, sinks should not be installed.
- Safety systems should be implemented to handle the risks of fire and electrical emergencies. An emergency shower and an eyewash facility should also be installed.
- Suitably equipped and readily accessible first-aid areas or rooms should be available near the BSL3 laboratory. The personnel of a BSL3 laboratory should ideally have received first-aid training.
- A mechanical ventilation system should provide an inward flow of air without recirculation.
- There should be a reliable and adequate electricity supply and emergency lighting to permit safe exit. A back-up system is highly important (e.g. a stand-by generator and a UPS to support alarm systems and other essential equipment such as biological safety cabinets, freezers, etc.)
- General requirements to the BSL3 facility are summarised in the annex to Chapter 1.

1.4 Procedures

Based on local risk assessments, a set of detailed standard operating procedures should be developed and implemented for the safe performance of all tasks carried out in the facility. As a rule, the following procedures should be adhered to [1,6,8]:

- Pipetting by mouth must be strictly forbidden.
- All technical procedures should be performed so as to minimise the formation of aerosols and droplets. The use of any sharp objects, such as hypodermic needles and syringes, should be avoided.
- All spills, accidents and overt or potential exposures to infectious materials must be reported to the laboratory supervisor. A written record of such accidents and incidents (including precautions that will be taken to avoid similar accidents in the future) should be maintained.
- There should be a procedure in place for emergency action to be undertaken after any unintended release of bacteria and possible exposure of staff, including a medical surveillance programme.
- A written procedure must be developed for the cleaning-up of all spills. All staff members must be trained regularly and should have a good knowledge of, and a high level of compliance with all biosafety instructions.
- A spill emergency kit should be available with all required material to undertake immediate action in the event of a spill.
- All staff should always have an appropriate mask in their gown to put on if there is an unintended release of bacteria.
- Potentially contaminated liquids must be decontaminated (autoclaved) before being discharged into the public sewer system.

1.5 Personal protective equipment (PPE)

The use of PPE should be regulated in local standard operating procedures and be based on a local risk assessment as well as national and international regulations. It is crucial that the agreed choice of PPE is accepted, respected and followed by all staff members and visitors [1,6,8].

Table 1, adapted from the WHO Laboratory Biosafety Manual [1], lists examples of personal protection items for laboratory workers [1,8].

Table 1. Examples of personal protective equipment

Equipment	Hazard corrected	Safety features
Laboratory coats, gowns, coveralls	Contamination of clothing	Back opening. Cover normal clothes
Plastic aprons	Contamination of clothing	Waterproof
Footwear	Impact and splash	Closed-toe
Goggles	Impact and splash	Impact-resistant lenses (must be optically correct or worn over corrective glasses). Side shields
Safety spectacles	Impact	Impact-resistant lenses (must be optically correct). Side shields
Face shields	Impact and splash	Shield entire face. Easily removable in case of accident
Respirators	Inhalation of aerosols	Designs available include single-use disposable, full-face or half-face air purifying, full-face or hooded powered air purifying (PAPR) and supplied air respirators
Gloves	Direct contact with microorganisms, cuts	Disposable, microbiologically approved latex, vinyl or nitrile; hand protection; mesh

Please refer to Chapter 5 for further details on laboratory safety levels and conditions when working with mycobacterial cultures.

1.6 The human resource component

Even the technically most advanced biosafety facility will fail if the laboratory staff neglects the biosafety rules. It is recommended that experienced technical staff members remain involved throughout the planning and implementation of the biosafety programme and establishment of the laboratory [1,6].

A well-designed training programme for biosafety, offered on an annual basis to all staff members, will raise the level of knowledge on the laboratory infection control plan. New staff members, as well as students and/or visiting researchers should be informed of all relevant rules and recommendations before being allowed to work in the laboratory. When they begin working in the laboratory they should never work independently, but be guided by experienced staff. It is recommended that the person responsible (often the laboratory supervisor) should inform them of all rules and regulations governing the laboratory and test their knowledge before they begin the actual laboratory work with the pathogen. Procedures governing medical emergencies and accidental exposure to infectious material should be in place. All reported events should be investigated and discussed extensively. This should be done in an atmosphere of cooperation to avoid staff members covering up details or becoming less inclined to report incidences/accidents in the future. A written suggestion for improvement should be prepared, describing in detail the preventive measures to be taken.

It is the responsibility of all staff members to achieve and maintain a safe working environment. Good biosafety laboratory practices should be known and embraced by all staff members, both to prevent accidents and to avoid a staff member claiming ignorance of the safety guidelines after an accident. There should be a clear consensus on the interpretation and application of the rules; otherwise they should be adapted so that all staff adhere to the local and international regulations.

1.7 Specific laboratory tasks related to hazards

As mentioned above, the risk of laboratory infections due to *M. tuberculosis* is related to the concentration of bacteria and the possible creation of infectious aerosols.

Biosafety measures must always be based on risk assessment [1,6,8]. Here are some examples:

- Handling of containers with clinical specimens. Even if it is unlikely to generate aerosols, exposure to the tubercle bacilli is possible. The outsides of containers used for the collection of clinical specimens are frequently contaminated by *M. tuberculosis* or other airborne pathogens. Specimen containers should therefore be handled carefully and only be opened in a biological safety cabinet.
- Centrifugation. Fluid may spill from centrifuge tubes or tubes may break, releasing aerosols. Only closed biosafety cups with appropriate and safe centrifugation tubes should be used. Centrifuge safety cups should therefore only be loaded/unloaded in the biological safety cabinet.

- Pipetting. Pipettes and Pasteur pipettes in particular are likely to generate bubbles that burst and form aerosols. Pipetting should therefore always be performed in biological safety cabinets and by using disposable pipettes. Pipetting by mouth is strictly forbidden.
- Mechanical homogenising (vortexing, grinding, blending). Appropriate procedures to avoid the induction of aerosols should be in place. Mechanical homogenisation should always be carried out in a biological safety cabinet, and even then it still creates a risk.
- Sonication, heating, or boiling of samples (e.g. for the extraction of nucleic acids). Appropriate procedures should be applied to avoid splashing and the creation of aerosols.
- Use of bacteriological loops. Loops charged with infectious material should not be directly heated in the flame of a Bunsen burner due to the risk of splashing and the creation of aerosols. Bunsen burners must not be used in a biosafety cabinet because this disturbs the flow of air. The use of disposable plastic loops is highly recommended.
- Animal studies. Major risks to staff are self-inoculation with material meant to infect the animals and exposure to aerosols from diseased animals. The litter of infected animals can also be contaminated and thus become a potential source of infection.
- Transport and shipping of *M. tuberculosis* strains. There are strict rules that must be followed when transporting suspected clinical samples, in particular cultured *M. tuberculosis*. These transport rules depend on arrangements within a country, between countries or with regard to air transportation. It is the responsibility of the shipping laboratory to identify the relevant regulations and follow them strictly. The use of dedicated couriers specialised in transport of BSL3 material and familiar with all regulations is highly recommended. All requested procedures must be fulfilled by the sender laboratory to ensure correct packing.
- Storing collections of *M. tuberculosis* isolates and reference strains. There should be local procedures with regard to biosafety for the storage of bacteria and clinical specimens containing bacteria. All freezers, fridges and other storage cabinets should be properly labelled, with the person in charge clearly marked. Access to the freezers should be limited to specific laboratory staff. The stock of BSL3 cultures should be registered in order to identify any illegal removal or unexplained disappearance.

References

1. World Health Organization (WHO). Laboratory biosafety manual. 3rd edition. Geneva: WHO; 2004. Available at: <http://www.who.int/csr/resources/publications/biosafety/Biosafety7.pdf>
2. Baussano I, Williams B, Pivetta E, Bugiani M, Scano F. Tuberculosis among healthcare workers. *Emerg Infect Dis* 2011, 17:488–494.
3. Fleming DO, Hunt DL. *Biological Safety: Principles and Practices*, 4th Edition. Washington: ASM Press; 2006.
4. Collins CH, Kennedy DA. *Laboratory-acquired Infections: History, Incidence, Causes and Preventions*, 4th edition. Oxford: Butterworth-Heinemann; 1999.
5. Sewell DL. Laboratory-acquired infections: Are microbiologists at risk? *Clin Microbiol Newsl.* 2006;1:1-6.
6. US Department of Health and Human Services, Public Health Service, Centers for Disease Control and Prevention, National Institutes of Health. *Biosafety in microbiological and biomedical laboratories*. 5th ed. Washington: CDC/NIH; 2009. Available at: <http://www.cdc.gov/biosafety/publications/bmb15/BMBL.pdf>
7. Miller JM, Astles R, Baszler T, Chapin K, Carey R, Garcia L, et. al. Guidelines for safe work practices in human and animal medical diagnostic laboratories. Recommendations of a CDC-convened, Biosafety Blue Ribbon Panel. *MMWR Surveill Summ.* 2012 Jan 6;61 Suppl:1-102.
8. World Health Organization (WHO). *Tuberculosis laboratory biosafety manual*. Geneva: WHO; 2012. Available at: http://apps.who.int/iris/bitstream/10665/77949/1/9789241504638_eng.pdf
9. European Committee for Standardization (CEN). *Laboratory Biorisk Management Standard CWA 15793:2008*. Brussels; 2011. Available at: <ftp://ftp.cenorm.be/PUBLIC/CWAs/wokrshop31/CWA15793.pdf>
10. CEN. *Laboratory Biorisk Management Standard CWA 15793: 2011*. Brussels; 2011. Available at: ftp://ftp.cenorm.be/CEN/Sectors/TCandWorkshops/Workshops/CWA15793_September2011.pdf
11. CEN. *Laboratory biorisk management Standard CWA 16393- Guidelines for the implementation of CWA 15793:2008*. Brussels; 2012. Available at: <ftp://ftp.cen.eu/CEN/Sectors/list/ICT/Workshops/CWA%2016393.pdf>
12. ECDC: Biorisk Initiative for Capacity Building and Knowledge Base Development (BRICK): Available at: http://ecdc.europa.eu/en/activities/microbiology/biosafety/Documents/101117_Bioriskproject_Description.p df
13. ECDC. *Laboratory networks and biosafety communities. How to make biosafety pan-European?* Available at: http://ecdc.europa.eu/en/publications/Publications/1108_MER_Biosafety.pdf

Annex 1

The following checklist provides criteria for the planning or overhaul of BSL3 laboratories [1,6,8].

Checklist for BSL3 laboratories	
1.	The BSL3 laboratory should be housed in a solid building, ideally separated from other disciplines.
2.	The BSL3 laboratory should be separated from other (BSL2) laboratories.
3.	The BSL3 laboratory can only be entered via an anteroom.
4.	Floors, walls, doors and working surfaces should be non-absorbing, resistant to acids, bases and decontaminants, easy-to-clean, and without sections that are hard to access. Seams, gaps and cracks should be completely caulked/grouted to seal them.
5.	The floor should be liquid-tight (higher skirting, welded seams).
6.	Doors should be self-closing.
7.	Windows should be sealed so they cannot be opened and are airtight.
8.	The entrance door should have a window to monitor the BSL3 laboratory.
Airflow	
9.	Negative pressure must be kept in the anteroom and the laboratory (minimum pressure difference of 15 Pa, e.g. -15 Pa in the anteroom and -30 Pa in the laboratory).
10.	The negative pressure needs to be monitored constantly and displayed outside the laboratory, preferable next to the entrance.
11.	If the negative pressure goes out of range, an audio-visual alert should be triggered in the anteroom and the laboratory.
12.	Air from the laboratory and the anteroom should be extracted via an independent air duct with a HEPA filter. The air intake duct does not need to contain a HEPA filter, but should have a one-way valve to prevent any backflow in case the negative pressure is not maintained.
13.	The ventilating system must have an emergency off-switch to prevent a build-up of positive pressure in the laboratory if the extraction system fails.
14.	The ventilating system for a BSL3 laboratory should be completely independent and separate from other ventilation systems to prevent cross-contamination.
15.	There should be a minimum of six to 12 complete air exchanges per hour in a BSL3 laboratory.
16.	The air intake duct should be separate from the exhaust duct to prevent airflow contamination between the two ducts.
Entrance and access	
17.	The entrance to the BSL3 laboratory should be marked with a biohazard sign, information on the containment level, details of responsible staff members and biosafety office (including telephone numbers).
18.	Access to a BSL3 laboratory should be restricted to authorised staff members and controlled by key cards/electronic passes.
19.	An uninterruptible power supply should provide emergency power.
20.	If staff technicians are allowed access, they should use personal protective equipment and be supervised by regular laboratory staff. Work should be carried out in the early morning when no viable cultures are being processed and the laboratory is relatively safe after multiple air exchanges during the night and UV treatment. Equipment touched by staff technicians has to be disinfected with 80% ethanol. Maintenance personal should be subject to regular occupational health checks.
21.	Depending on the size of the working space, there should be a sealed emergency exit.
Anteroom	
22.	A door interlock system should be used to prevent the simultaneous opening of doors, thus preventing leakage of potentially contaminated air from the BSL3 lab to the corridor. It should be possible to overrule this system.

23.	The anteroom is normally considered a part of the BSL3 area because the anteroom and the laboratory have the same ventilating system, but in fact the anteroom is a transition zone between uncontaminated and potentially contaminated areas. It is therefore recommended that the anteroom is split into two parts: an unclean and a clean zone. The two zones should be clearly marked, e.g. by a laboratory bench.
24.	Some laboratories only have a small anteroom that is too small to be divided into two zones. If this is the case, laboratory coats should be left in the BSL laboratory.
25.	The anteroom should have a soap dispenser, an alcohol dispenser, a sink and a disposable hand towel dispenser. The dispensers as well as the faucet/tap should be hands-free.

Checklist for BSL3 laboratories

26.	The waste container and the container for worn lab coats should be sealable. Coats have to be autoclaved before being laundered. Towels are considered relatively harmless and do not need to be autoclaved.
27.	An emergency eyewash facility should be installed near the sink.

Checklist for BSL3 laboratories

Biological safety cabinets

28.	Class I and II biological safety cabinets are acceptable. For maximum containment at the source, the installation of a Class III biological safety cabinet may be considered, although this would result in ergonomic disadvantages.
29.	The biological safety cabinet should be positioned in the laboratory so that airflow would not be disturbed by personnel or open doors. A Class III biological safety cabinet is not affected by this.
30.	Air extracted from a biological safety cabinet can be discharged in three ways: <ol style="list-style-type: none"> 1. Air can be recirculated to the room, which is not advisable because of possible biological safety cabinet filter leaks which then would introduce contaminated air to the laboratory. This is not just a hypothetical risk, especially when biological safety cabinets are not well-maintained. 2. The biological safety cabinet features a continuous airflow connection with a bypass for air treatment. 3. With a 'thimble' or 'canopy hood', extracted air can be recirculated to the room or discharged to the outside of the building via a dedicated duct or through the main extraction system. When a biological safety cabinet is switched on, it also contributes to the negative pressure in the laboratory. However, only options 2 and 3 ensure that the negative pressure is still maintained when the safety cabinet is off.
31.	Biological safety cabinets have to be tested and certified at least once a year. Between maintenance intervals safety cabinets are decontaminated by being fumigated with formaldehyde gas.

Digitalisation of information

32.	Any paper-based communication between the BSL3 laboratory and the area outside the laboratory should be avoided. Instead, a computer-based laboratory management information system should be used.
-----	---

Waste

33.	Containers for BSL3 waste should be solid, unbreakable, closable and autoclavable.
34.	A BSL3 laboratory should be equipped with an autoclave to decontaminate BSL3 waste. An autoclave with openings toward the laboratory and the hallway is ideal, as loading of BSL3 occurs directly from the BSL3 containment area. A stand-alone autoclave inside the BSL3 laboratory is also acceptable, provided there is an adequate solution to deal with the contaminated steam/condensate. If both options are not possible, an autoclave in the vicinity of the BSL3 laboratory (same building) is acceptable, but containers need to be leak-proof and should only be moved under the supervision of the BSL3 laboratory, without any intermediate storage.

Wastewater

35.	If the BSL3 laboratory has no sink, liquid waste has to be inactivated in an autoclave.
36.	If a sink is to be installed in a BSL3 laboratory, care should be taken that wastewater is not discharged in the public sewer system. Instead, wastewater should be collected in a dunk tank and inactivated (heat, chemicals) before it is discharged.
37.	Although the anteroom is officially considered part of the BSL3 laboratory, the risk of contamination by BSL3 microorganisms is considered to be so low that wastewater does not have to be decontaminated.

2 Quality assurance

Daniela Homorodean, Dimitrios Papaventsis, Tiina Kummik, Vibeke Østergaard Thomsen

Revised by Daniela Homorodean (2015)

2.1 Background and principles

National TB programmes are to be supported by laboratories that provide quality-assured and reliable results. Several European standards (ISO 17025, ISO 15189, ISO 9001) are dedicated to the management of quality assurance [1].

Quality assurance covers several distinct procedures that help to improve the quality of test procedures and therefore the confidence in national TB programmes. National policies regarding the quality of laboratory results constitute an essential component of national TB programmes, and the provision of sustainable high-quality services is one of the key roles of any NRL. Guidance for national TB programmes and NRLs on establishing a standardised assessment system for the laboratory network focused on microscopy, was published by GLI (Global Laboratory Initiative), and proposed 11 standards for TB Microscopy Network Accreditation [2]. It is recommended that every laboratory develops, establishes, and strictly follows quality assurance procedures for tests used on patients' specimens/isolates. Obviously, quality can be equally good in laboratories with or without a formal QA system, but adherence to standards is helpful in identifying problems and the improvement of quality in a systematic manner.

For laboratories, the formal standards adopted by the majority of European countries are the European standards: ISO 17025 (General requirements for the competence of testing and calibration laboratories), ISO 15189 (Medical laboratories – particular requirements for quality and competence), and ISO 9001 (Quality management systems – Requirements). In 2012, the revised version of ISO 15189 (Medical laboratories - Requirements for quality and competence) was issued, replacing the second edition (ISO 15189:2007) [1]. Accreditation by the two former standards addresses the quality system and provides a technical assessment, in contrast to certification by ISO 9001, which addresses the quality system only.

ISO 17025 and ISO 15189 are very similar in their specific requirements. ISO 17025 emphasises the needs of customers, whereas ISO 15189 emphasises the need of patients and clinicians. Accredited laboratories often only have ISO 17025 implemented, as ISO 15189 was only published in 2003. The decision to implement one or the other standard may be based on local and national requirements, the status of a health laboratory (commercial or public), proximity to clinical departments (diagnostic laboratory, reference laboratory), and the needs of other laboratories at the institute (due to accreditation fees).

Table 2. Overall scope of ISO 17025 and ISO 15189

ISO 17025. General requirements for the competence of testing and calibration laboratories	ISO 15189:2012 Medical laboratories – Requirements for quality and competence
<p>‘ISO/IEC 17025:2005 specifies the general requirements for the competence to carry out tests and/or calibrations, including sampling. It covers testing and calibration performed using standard methods, non-standard methods, and laboratory-developed methods.</p> <p>It is applicable to all organisations performing tests and/or calibrations. These include, for example, first-, second- and third-party laboratories, and laboratories where testing and/or calibration forms part of inspection and product certification.</p> <p>ISO/IEC 17025:2005 is applicable to all laboratories regardless of the number of personnel or the extent of the scope of testing and/or calibration activities. When a laboratory does not undertake one or more of the activities covered by ISO/IEC 17025:2005, such as sampling and the design/development of new methods, the requirements of those clauses do not apply.</p> <p>ISO/IEC 17025:2005 is for use by laboratories in developing their management system for quality, administrative and technical operations. Laboratory customers, regulatory authorities and accreditation bodies may also use it in confirming or recognising the competence of laboratories. ISO/IEC 17025:2005 is not intended to be used as the basis for certification of laboratories.’ [1]</p>	<p>In this new version, some chapters have been renamed and some requirements are more detailed both in management and technical requirements. There are new normative sections (Reporting and Release of results) and annexes B and C from the former became new sections (Laboratory information management and Ethical conduct, respectively).</p>

Laboratory accreditation/certification (by a national body providing official recognition of laboratory quality) according to these standards recognises the professional competence of the laboratory and provides an official indicator of high performance standards. Central terms are given in Table 3 and further terms are defined in the publication ‘International vocabulary of metrology – basic and general concepts and associated terms’ (VIM) [3] and the ‘IUPAC Compendium of Chemical Technology – the gold book’ [4]. This chapter outlines the most important requirements from ISO/IEC 17025 and ISO 15189:2012. It takes into account the special requirements imposed by the medical environment and the contribution of medical laboratory services to patient care. It recognises that medical laboratories not only test patient samples, but also offer advisory, interpretative, and educational services. The full text of these standards is available for purchase online [1].

Table 3. Central terms and abbreviations in quality assurance

Quality assurance	A system for continuously improving and monitoring the reliability, efficiency and clinical utilisation of laboratory tests. Quality control, quality improvement and method validation are integral components of quality assurance
Quality assessment	<p>A process of regular performance checks to ensure that a method is performing as expected. Internal quality assessment (IQA) includes controls tested in parallel with specimens/isolates. This evaluates the precision and accuracy of the test results, the performance of the test reagents and how well laboratory staff perform when carrying out the test.</p> <p>External quality assessment (EQA) or proficiency panels are specimens/isolates received from an independent organisation in order to assess the performance of the participating laboratory. Inter-laboratory comparison is an alternative when proficiency panels are not available and includes the exchange of specimens/isolates with other laboratories (usually at least three) that perform the same tests.</p>
Validation	Validation is the ‘confirmation by examination and the provision of objective evidence that the particular requirements for a specific intended use are fulfilled.’ (ISO 17025)
Key indicators	For each test, key indicators should be identified and followed routinely in order to monitor trends (early detection of deviations).

2.2 Selection and implementation of tests

The laboratory should use testing methods that meet the needs of the customer and include procedures for sampling, handling, transport and the storage and preparation of specimens/isolates. Methods should apply international, regional, or national standards by reputable technical organisations, from scientific journals, or as specified by a kit/equipment manufacturer. Laboratory-developed methods, or methods adopted by the laboratory may also be used if appropriate and validated. The laboratory should confirm that it can properly perform the methods before introducing the tests [6,7].

2.3 Validation

Non-standard methods, laboratory-developed methods, standard methods used outside their intended scope, modifications of standard methods, and changes in established methods should be validated. Validation is the 'confirmation by examination and the provision of objective evidence that the particular requirements for an intended use are fulfilled' (ISO 17025). Validation includes specification of written requirements, determination of the assay characteristics, checking that the requirements are fulfilled by the assay and a statement on the validity. For standardised methods it is only necessary to validate that the method works locally as expected. Validation is a relative process: sensitivity and specificity of diagnosis is calculated in relation to a standard, verified procedure.

Part of the validation may have been carried out by the manufacturer or by other laboratories. Since the introduction of the 'in vitro diagnostic directive' (IVD) [5] in 2003, manufacturers have been legally bound to carry out extensive validation. In this case, the validation can be a reduced equivalent, but the laboratory still has to verify that the method works locally as expected. In all cases, the laboratory should have access to documentation equivalent to a full validation and assess whether the validation is relevant to the use and whether the requirements are fulfilled.

It is not possible to recommend one validation method for all tests. Validation can be done using:

- a comparison of results achieved with other methods;
- inter-laboratory comparisons;
- a systematic assessment of factors influencing the result; and
- an assessment of the uncertainty of the results, based on a scientific understanding of the theoretical principles of the method and practical experience.
- an overview of validation principles can be found in Westgard (2008) [6] and Westgard (2010) [7]. In addition, the following factors may be assessed:
- coefficients of variation;
- uncertainty of results;
- detection limit;
- sensitivity;
- specificity;
- linearity;
- limit of repeatability and/or reproducibility; and
- robustness.

In many cases, the range of values has been simplified due to lack of information.

2.4 Control and trend monitoring by key indicators

Appropriate internal quality assessments (IQAs) should be selected and run in parallel with specimens/isolates in order to monitor routine performance regularly (e.g. control slides for microscopy). Reference strains can be purchased from different strain collections [1,2,3,5,6].

Key indicators can be used to monitor performance trends over time and allow early identification of deviations (e.g. proportion of contaminated cultures or proportion of inconclusive IGRA results over a certain time period). The NRL from each country provides guidelines for IQAs in accordance with the ISO standard requirements, the methods used and local conditions (infrastructure, workload, equipment and staff). Examples of IQAs can be found in Chapters 3 to 7.

External quality assessment (EQA) programmes are essential parts of quality assurance. Programmes of relevance for mycobacteriology laboratories are available through INSTAND e.V., the United Kingdom National External Quality Assessment Service (UK NEQAS), the United States' Centers for Disease Control (US CDC), LabQuality, and the WHO supranational TB reference laboratories, to which all national TB reference laboratories have links. If EQA programmes for a test are not available, exchanges with other laboratories can be arranged. A minimum of three laboratories should participate; however, EQA programmes do not replace IQA [2].

2.5 Physical and environmental conditions

The basic set-up of a laboratory (energy supply, lighting, environmental conditions) should be conducive to its testing activities. Physical and environmental conditions that can negatively affect results should be monitored and documented. Areas with incompatible activities should be separated (e.g. primary specimens and mycobacterial isolates and pre- and post-amplification areas) and precautions should be taken to prevent cross-contamination. Access to and use of laboratories must be controlled if this will affect the quality of tests. Measures should also be taken to ensure good housekeeping in the laboratory, thus improving biosafety (Chapter 1) [1,2,3,5,6].

2.6 Equipment

Equipment and related software must achieve the required level of accuracy and comply with specifications relevant to the tests. Procedures for handling, storage, use and maintenance should ensure the proper functioning of the equipment and prevent contamination or deterioration. Equipment with a measuring function must be calibrated initially and regularly thereafter. Procedures should be in place to ensure that equipment suspected of malfunction is not used until checked.

Records should be maintained for critical equipment: manufacturer's name; identification and serial number; compliance checks; location; manufacturer's instructions; results; reports; certificates of all calibrations/adjustments; acceptance criteria; date of next calibration; maintenance plan; registrations of damage, malfunction, modification or repair. The equipment itself should be labelled with the status of calibration and date of last and next recalibration [1,2,3,5,6].

2.7 Management and staff

Managerial and technical staff must be authorised to carry out tests to the required standards. All necessary resources must be available to them. Management and staff should be free of any conflicts of interest and key personnel should have appointed deputies. One person should be appointed quality officer and laboratory staff should understand that quality is everyone's responsibility. Management must document the competencies of the staff to ensure that equipment is properly handled, and that they know how to carry out testing, assess and approve results and sign reporting forms. In some countries, formal authorisation may apply to some staff members. Staff members giving guidance or interpreting results should be knowledgeable about the applied technology and the significance of the results. Ideally, staff should be employed in permanent positions or have signed a contract. Job descriptions should be available for managerial, administrative, and technical staff involved in testing [7].

2.8 Documentation and registration

Laboratories document their policies and procedures for testing and equipment use (in their local language) to ensure the quality of results. All documents must be reviewed and approved by authorised staff before being issued. They must also be read and understood by the relevant staff and revised on a regular basis. The use of expired/amended documents must be prevented. All documents should be easily accessible. Handwritten corrections and annotations should be incorporated quickly into the official version of the document. Handwritten corrections should be dated and signed with initials [1,2,3,5,6].

Procedures for registration of specimens should include specimen identification, access, archiving, maintenance, and disposal. Procedures should specify how long registration forms have to be kept on file. Registration forms should be clearly legible, accessible, remain confidential to outsiders, and be kept in conditions that prevent damage and loss. Calculations and data transfers should be subject to appropriate and systematic checks. Registration documents should make it possible to replicate the entire testing process. When errors are identified, the correct information should be entered next to the error, without overwriting the incorrect entry, and then signed or initialled and dated by the staff member who corrected the information.

Electronic data must be protected (entry; storage, including back-up, access, transmission, and processing) according to the national data protection policy. In addition, in-house developed computer software ought to be documented and validated.

2.9 Sampling guidance, review of requests, and service to customers

The laboratory provides the customer with standardised operating procedures (based on existing guidelines) for sampling that are easily accessible at the sampling location (e.g. online). The sampling guidelines address all factors that need to be controlled in order to ensure the validity of the test (e.g. specimen quality and volume, specimen number, transportation time, and temperature). When specimens are sub-optimal or unacceptable for testing, the results report should indicate this and/or this should be communicated to the appropriate staff members [1,2,3,5,6].

Procedures must be implemented for the review of requests, tenders, and contracts for testing according to the national guidelines. For routine diagnostics, recommendations from the laboratory and the completed request form is sufficient. The laboratory will identify customer needs, including guidance and analysis of results. In the event of major deviations/delays, the customer should be informed.

2.10 Subcontracting, services, and supplies

It is the responsibility of the laboratory to ensure that all work undertaken by subcontractors is completed to meet the required standards. Examples are the calibration of equipment or second-line drug susceptibility testing of *M. tuberculosis* at another laboratory. There is a need for policies and procedures for services and supplies that directly influence diagnostic quality: procedures cover the purchase, receipt and storage of reagents, as well as compliance of supplies with standards and regulations. The laboratory is advised to assess suppliers of critical services and supplies. CE-marked reagents are produced according to the EU directive and are in compliance with national regulations.

2.11 Complaints, errors and corrective actions

Policies and procedures regarding complaints, deviations and corrective actions should be established and registered. When errors are identified, the significance should be assessed and corrective actions implemented. The customer should be informed and the results corrected or withdrawn. It should then be assessed when the testing can be resumed. If the assessment indicates that the error could happen again (systematic error), corrective action must be taken immediately and its effect controlled. All corrective actions have to be authorised first [1,2,3,5,6].

2.12 Improvements

Senior management should be committed to developing, implementing and improving the quality assurance system. The laboratory should revise the quality system regularly by establishing a quality policy and formulating quality objectives. Improvement methods include preventive actions, assessments of complaints and deviations, corrective actions (as above), observations from internal audits, data analyses and management evaluations.

Internal audits should be carried out annually by trained, qualified staff not involved in the audited activities. Management reviews carried out annually assess the suitability of policies and procedures, staff reports, results from internal audit(s), corrective and preventive actions, assessments from external parties, results from external proficiency panels or inter-laboratory comparisons, changes in workload, customer enquiries, complaints and other relevant factors [1,2,3,5,6].

2.13 Reporting and releasing results

It is essential that the results of each test are reported accurately, clearly, unambiguously, and objectively. Each report includes a title, the name and address of the laboratory, the unique identification of the test report (all pages), an end-of-report message (or other indicator at the end of the report), the name and address of the customer, the method used, a description of specimens/isolates (including sampling date), patient identification, specimen type, date of receipt, test result, release date, and name of the person(s) authorising the report [1,2,6,7].

References

1. International Organization for Standardization. ISO Standards. Geneva: ISO; 2011. Available at: http://www.iso.org/iso/iso_catalogue/catalogue_tc/catalogue_detail.htm?csnumber=39883 and http://www.iso.org/iso/iso_catalogue/catalogue_tc/catalogue_detail.htm?csnumber=42641
2. TB Microscopy Network Accreditation – An assessment tool. First English Edition, October 2013. Available at: <http://www.stoptb.org/wg/gli>
3. International Organization of Legal Metrology (OIML), Joint Committee for Guides in Metrology. International vocabulary of metrology – basic and general concepts and associated terms (VIM). Paris: International Organization of Legal Metrology; 2007. Available at: http://www.oiml.org/en/files/pdf_v/v002-200-e07.pdf/view
4. International Union of Pure and Applied Chemistry. IUPAC Compendium of chemical terminology – the gold book. Research Triangle Park, NC: IUPAC; 2005-2009 [cited 28 July 2015.] Available at: <http://goldbook.iupac.org>
5. Directive 98/79/EC of the European Parliament and of the Council of 27 October 1998 on *in vitro* diagnostic medical devices. Available at: <https://eur-lex.europa.eu/legal-content/EN/TXT/?uri=CELEX:31998L0079>
6. Westgard, JO. Basic method validation. 3rd edition. Madison, WI: Westgard QC; 2008.
7. Westgard, JO. Tools, technologies and training for healthcare laboratories. Madison, WI: Westgard QC; 2009. Available at: <http://www.westgard.com>

3 The diagnosis of TB infection

Dimitrios Papaventsis and Vladyslav Nikolayevskyy

Revised by Dimitrios Papaventsis and Vladyslav Nikolayevskyy (2015)

3.1 Background and principles

Most people who are initially infected with *Mycobacterium tuberculosis* do not develop active TB. This state (when a person infected with the TB bacillus has not developed active TB) is called latent TB infection (LTBI) [1]. It is characterised by persistence and a low-rate multiplication of viable *M. tuberculosis* bacilli within macrophages and evidence of an immune response against the bacterium, but without clinical manifestation and radiological and bacteriological evidence of active disease. One third of the world's population (almost two billion people worldwide) is estimated to be latently infected with TB – an enormous reservoir of potential TB cases [2]. Latency can be maintained for the lifetime of the infected person.

Primary infection leads to active disease in 10% of infected individuals, mostly within two years of infection [3]. When the host immune response weakens (e.g. through HIV infection, malnutrition, the use of steroids/other immunosuppressive medications, or advanced age), reactivation of latent infection may occur [4].

Being non-infectious, those latently infected with the TB do not pose an immediate risk of TB transmission. Detection of the LTBI, however, is an important means of global TB control and constitutes a major part of the WHO Global Plan to Stop TB [5]. Putting people with LTBI on chemoprophylaxis significantly reduces their risk of developing active TB. An ideal test for LTBI diagnosis should meet the following criteria [5]:

- High sensitivity in all populations at risk;
- High specificity regardless of BCG vaccination and infection with environmental mycobacteria;
- Reliability and stability over time;
- Objective criteria for positive result, affordability and easy administration;
- Ability to identify recently infected individuals with increased risk of progression to active TB.

There are currently two groups of tests for LTBI diagnosis: tuberculin skin tests (TST) and interferon- γ release assays (IGRA).

3.1.1 Immune response to *M. tuberculosis*

The immune response to *M. tuberculosis* is multifaceted. Immunological mechanisms involved in maintaining a latent infection are complex, but are clearly necessary to prevent reactivation [1]. When the human host is infected by *M. tuberculosis*, there are three potential outcomes (Figure 2):

- Spontaneous healing.
- Latency. In most cases, mycobacteria are initially contained and disease develops later as a result of reactivation. The granuloma that forms in response to *M. tuberculosis* consists of macrophages, which can differentiate into epithelioid macrophages or multinucleate giant cells, CD4 and CD8 T-cells, and B cells. The T-cells produce interferon- γ , which activates macrophages. CD8 T-cells can lyse infected macrophages or kill intracellular bacteria. Tumour necrosis factor (TNF) is produced by macrophages and T-cells. Dendritic cells are also present, and a mature granuloma is surrounded by fibroblasts. *M. tuberculosis* is present within the macrophages and extracellularly.
- Development of TB directly after infection in the immunocompromised host: On depletion of CD4 T cells (e.g. during HIV infection), the granuloma does not function as well, production of interferon- γ may decrease, and macrophages are less activated. As a result, *M. tuberculosis* begins to multiply and active TB develops. In the case of TNF neutralisation, the cells within the granuloma are no longer as tightly clustered, perhaps owing to chemokine or adhesion-molecule dysregulation. In addition, the macrophages are not as activated. These defects lead to a disorganised granuloma that is less able to control infection and greater immunopathology [1].

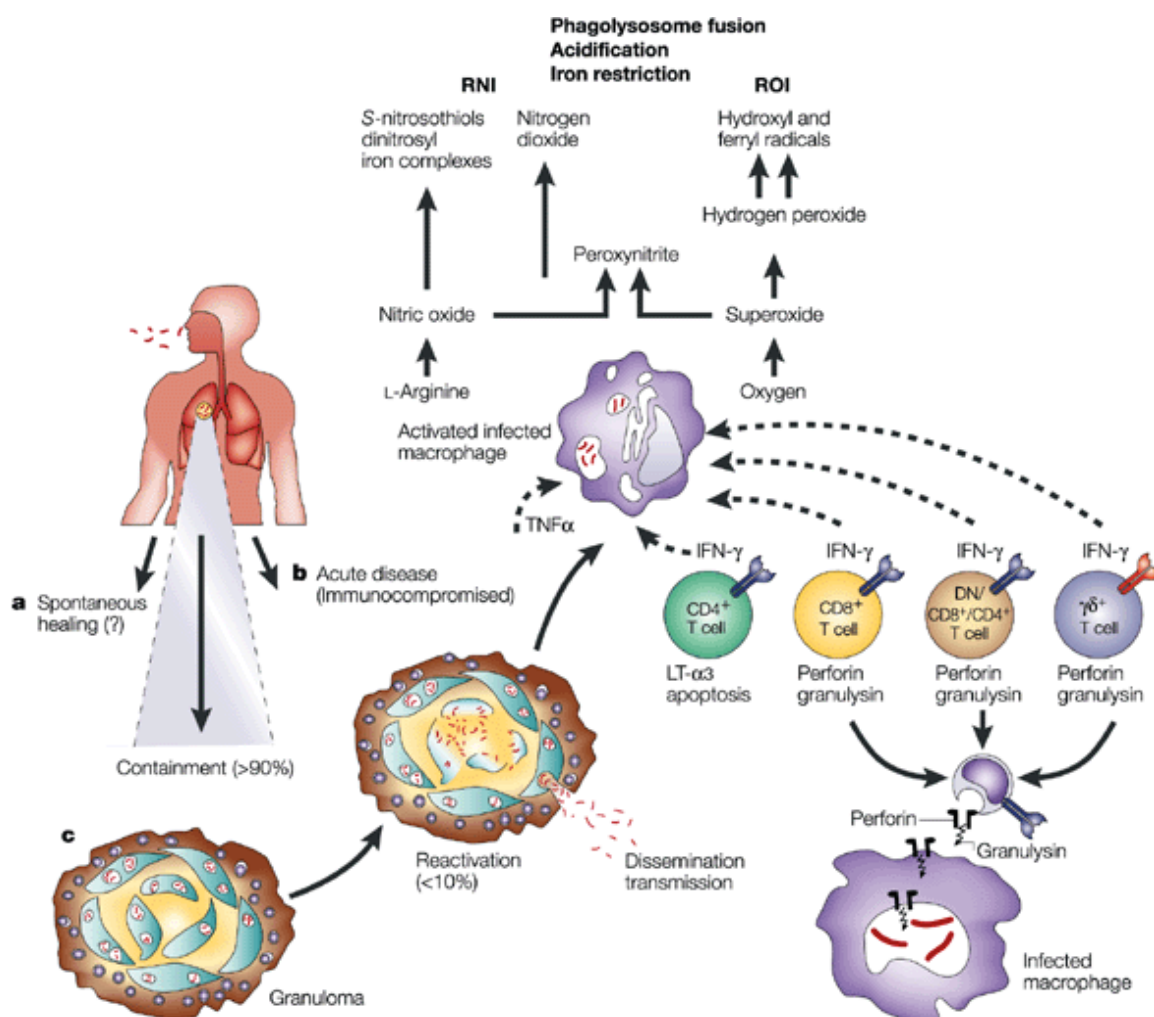
Figure 2. Potential outcomes of human host infection by *M. tuberculosis*

Reprinted by permission from Macmillan Publishers Ltd: *Nature Reviews Immunology*, S. Kaufmann, How can immunology contribute to the control of tuberculosis? 2001 Oct;1 [17]

Although the host response is essential to controlling the infection, *M. tuberculosis* participates in the establishment of latency by using various strategies to evade elimination by the host [1]. *M. tuberculosis* can subvert various antimycobacterial functions of macrophages. Once engulfed, *M. tuberculosis* ends up in a phagosome, the maturation of which is arrested at an early stage [17]. Within the phagosome, *M. tuberculosis* is subject to the antimycobacterial effect of reactive nitrogen intermediates (RNI) [1]. *M. tuberculosis* inhibits phagosomal acidification and prevents fusion with lysosomal compartments. The bacilli can also inhibit the MHC class II-dependent antigen presentation pathway.

3.2 The tuberculin skin test (TST)

First introduced in 1890, the TST is an intradermal injection of purified protein derivative (PPD). The PPD is a crude antigenic mixture, shared among *M. tuberculosis*, *M. bovis*, and other non-tuberculous mycobacteria (NTM) [6].

The test measures in vivo a delayed-type hypersensitivity reaction based on immunological recognition of mycobacterial antigens in exposed individuals. Mycobacterial antigens are injected below the epidermal layer, causing infiltration of antigen-specific lymphocytes and the elaboration of inflammatory cytokines. This inflammatory reaction results in the characteristic indurated area at the site of injection.

Until recently, the TST was the only tool for detecting LTBI. Limitations of the test include:

- a high proportion of false positive and false negative results;
- difficulty in separating true infection from the effects of BCG vaccination and non-tuberculous mycobacteria infection;

- technical problems in administration;
- immune response boosting after repeated TST;
- complicated and subjective interpretation; and
- a need for a second visit.

3.3 Interferon- γ release assays (IGRAs)

3.3.1 Introduction

The QuantiFERON-TB Gold (QFT-G, by Qiagen GmbH, Hilden, Germany) and the T-SPOT (by Oxford Immunotec Limited, Abingdon, the United Kingdom (UK)) are two in-vitro ex-vivo tests for measuring cell-mediated immune responses (CMIR) to peptide antigens that simulate mycobacterial proteins. These antigens, ESAT-6, CFP-10 and TB7.7 (p4) (used only in QFT-G) are absent from all BCG strains and from most non-tuberculous mycobacteria with the exception of *M. kansasii*, *M. szulgai* and *M. marinum* [7-9]. Individuals infected with *M. tuberculosis* complex organisms (*M. tuberculosis*, *M. bovis*, *M. africanum*, *M. microti*, *M. canetti*) have mononuclear cells in their blood that recognise these mycobacterial antigens. This recognition process leads in vitro to the stimulation and secretion of Interferon- γ (IFN- γ) from sensitised T-cells. The detection and subsequent quantification of IFN- γ , measured by enzyme-linked immunoassay (QuantiFERON) or enzyme-linked immunospot (T-SPOT), forms the basis of these tests [10]. Both tests are intended for use in conjunction with risk assessment, radiography, and other medical and diagnostic evaluations. Potential advantages of IGRAs over TST include: greater sensitivity; higher specificity (less influenced by BCG vaccination and non-tuberculous mycobacteria infection; less influence by technical problems in administration and interpretation and the need for only one visit.

3.3.2 Current national guidelines and the clinical use of IGRAs

With the growing evidence, many national guidelines for LTBI diagnosis now include IGRAs although most countries continue to recommend and use TST. A recent review [18], based on thirty-three guidelines and policy papers from 25 countries and two international organisations, demonstrated considerable diversity in the approaches. Guidelines are predominantly available in high-income countries with established LTBI screening programmes. Four approaches are generally adopted:

- two-step approach of TST first, followed by IGRA, either when the TST is negative (to increase sensitivity, mainly in immunocompromised individuals), or when the TST is positive (to increase specificity, mainly in BCG-vaccinated individuals);
- either TST or IGRA, but not both;
- IGRA and TST together (to increase sensitivity)
- IGRA only, replacing the TST.

There is also a trend towards using IGRAs alone prior to anti-TNF- α therapy. Some guidelines are still not proposing IGRA use in children under five years of age. Most of the current guidelines do not use objective, transparent methods to grade evidence and recommendations, and rarely disclose conflicts of interests. Existing national guidelines on LTBI diagnosis in EU/EEA countries are listed in Table 4.

Table 4. List of national TB infection diagnosis guidelines

Country	Guideline
Austria	Schmidgruber B. Guidelines for the diagnosis of latent tuberculosis in canton Vienna; 2011; Gesundheitsdienst (Department of Public Health) of Vienna, Austria.
Bulgaria	Markova R. Guidelines for the diagnosis of latent tuberculosis in Bulgaria; 2011; Dept. Immunology and Allergology, National Centre of Infections and Parasitic Diseases; Sofia, Bulgaria
Croatia	Katalinic-Jankovic V. Guidelines for the diagnosis of latent tuberculosis in Croatia; personal communications with Vera Katalinic-Jankovic. 2011; Croatia National Institute of Public Health; Zagreb, Croatia
Czechia	Czech Thoracic Society. Recommendation of Czech Thoracic Society for QuantiFERON- TB Gold test; 2005; Research Institute for Tuberculosis and Respiratory Diseases; Prague, Czechia.
Denmark	Kruse, Hvass, Wejse <i>et al</i> , Tuberkulosebekæmpelse i Danmark, 2018; Denmark
Finland	Suositus tuberkuloosin kontaktiselvityksen toteuttamiseksi, 2011; Terveystieteiden ja Hyvinvoinninlaitos, Finland
France	Test de détection de la production d'interféron-γ pour le diagnostic des infections tuberculeuses, 2006; Haute Autorité de Santé, France
Germany	Neue Empfehlungen für die Umgebungsuntersuchungen bei Tuberkulose Deutsches Zentralkomitee zur Bekämpfung der Tuberkulose. New Recommendations for Contact Tracing in Tuberculosis German Central Committee against Tuberculosis. Germany
Hungary	Nagy E., Szabó N.; Kónya J. Egészségügyszakmai irányelv - A tuberkulózis mikrobiológiai diagnosztikájáról; 2018; Hungary
Ireland	Guidelines on the Prevention and Control of Tuberculosis in Ireland, 2014; Health Protection Surveillance Centre, Ireland
Italy	Aggiornamento Delle Raccomandazioni Per Le Attività Di Controllo Della Tuberculosis: Gestione dei contatti e della tubercolosi in ambito assistenziale, 2009; Ministero del Lavoro della Salute e delle Politiche Sociali, Italy
Latvia	Clinical guidelines for tuberculosis; Latvian Association of Tuberculosis and Lung diseases Doctors Riga 2014; Algorithms for tuberculosis diagnostics, updated 2019, Latvia
Lithuania	R. Zablockis, E. Danila, S. Miliauskas, K. Malakauskas, E. Davidavičienė, E. Vasiliauskienė, G. Musteikienė, K. Miškinis, R. Matulionytė, A. Vitkauskienė; Plaučių tuberkulozės diagnostikos ir gydymo rekomendacijos, 2018; Lithuania
Malta	Dr Analita Pace Axiaq, 'Prevention, Control and Management of Tuberculosis: A National Strategy for Malta', 2012; Malta
The Netherlands	Interferon Gamma Release Assays bij de diagnostiek van tuberculose, 2011; IGRA-werkgroep Commissie voor Praktische Tuberculosebestrijding, the Netherlands
Norway	Tuberkuloseveilederen som e-bok, 2011; Folkehelseinstituttet, Norway
Poland	Zalecenia postępowania w zapobieganiu i leczeniu gruźlicy u chorych leczonych antagonistami TNF-α / Recommendations for prophylaxis and management of tuberculosis in patients treated with TNF-α antagonists, 2008, Poland
Portugal	Tuberculose Latente: Projecto de expansão dos testes IGRA, 2010; Programa Nacional de Luta Contra a Tuberculose (PNT), Portugal
Romania	Homorodean D., Moisiu A., National Guide for the TB Laboratory Network, 2022, Romania
Slovakia	Slovakian Guidelines on Latent Tuberculosis Testing, 2010; Ministerstva Zdravotníctva Slovenskej Republiky, Slovakia
Slovenia	P. Svetina, S. Grm Zupan, M. Žolnir-Dovč, M. Košnik. Latent infection with <i>Mycobacterium tuberculosis</i> , 2015, Slovenia
Spain	Grupo de trabajo de la Guía de Práctica Clínica sobre el Diagnóstico, el Tratamiento y la Prevención de la Tuberculosis. Centro Cochrane Iberoamericano, coordinador. Guía de Práctica Clínica sobre el Diagnóstico, el Tratamiento y la Prevención de la Tuberculosis. Plan de Calidad para el Sistema Nacional de Salud del Ministerio de Sanidad, Política Social e Igualdad. Agència d'Informació, Avaluació i Qualitat en Salut (AIAQS) de Catalunya; 2009. Guías de Práctica Clínica en el SNS: AATRM Nº 2007/26. Spain
Switzerland	Handbuch Tuberkulose (Rohfassung), 2011; Kompetenzzentrum Tuberkulose, Switzerland

Information included in the different national guidelines and recommendations suggests that IGRAs are increasingly being recommended, primarily in low-incidence settings, as they offer a higher specificity combined with logistical advantages [19]. TST is still favoured in high-incidence and low-resource settings.

In general, evidence suggests that screening for LTBI (using both TST and IGRA) should ideally be confined to those who are at sufficiently high risk of progressing to disease and who will benefit from chemoprophylaxis should they test positive.

The clinical use of IGRAs in different groups has been recently reviewed and policy papers have been published by international organisations including WHO and ECDC [20-23]. WHO generally discourages use of IGRAs and recommends using TST, but only in low- and middle-income settings, regardless of HIV status. The ECDC approach is based on TB incidence. In high-incidence settings, the ECDC suggests not to use IGRAs to diagnose LTBI since the focus of prevention and control is on identifying and treating active TB cases. In low-incidence settings a two-step approach is suggested. For active TB diagnosis, ECDC suggests that IGRAs should not be a replacement for standard diagnostic methods and generally do not have an added value in most clinical situations, when combined with standard methods for diagnosing active TB. However, in certain clinical situations (e.g. patients with extrapulmonary TB, patients who test negative for acid-fast bacilli in sputum and/or negative for *M. tuberculosis* after culture, TB diagnosis in children, or in the differential diagnosis of infection with non-tuberculous mycobacteria), ECDC suggests that IGRAs could contribute supplementary information as part of the diagnostic process and laboratory management. Overall, the contact tracing practices in adults appear to suggest a clear trend towards an increased use of IGRAs, especially in low-incidence countries, mostly as a two-step strategy [18].

3.3.3 Predictive value of IGRA for progression to active TB

Existing evidence suggests that both TST and IGRA are acceptable but imperfect tests and neither test can accurately differentiate between LTBI and active TB, distinguish reactivation from reinfection, or accurately predict progression from LTBI to active disease [19]. In a recent meta-analysis [24] based on a combined sample size of 26 680 individuals and data derived from 15 longitudinal studies it was concluded that neither IGRA nor TST accurately predict the risk of developing active TB, although use of IGRAs in certain groups might reduce the number of people considered for chemoprophylaxis.

Overall, the currently available evidence suggests that the predictive value of IGRAs for progression to active TB disease is low and only marginally (non-significantly) higher than that of the TST [19]. There is also limited evidence suggesting that IGRA conversion detected using multiple testing may have a greater predictive value than single IGRA results as it may indicate recent infection [25]. With regard to high-risk populations (e.g. HIV-infected individuals) there are currently no data suggesting that IGRAs are better in predicting active TB in this group than the TST [19,26].

To conclude, the available evidence suggests that both TST and IGRA have limited predictive values and their usefulness is restricted to identification of those who would potentially benefit from preventive therapy. Current and future studies will help establish the place and role of IGRAs in TB clinical and laboratory management and potentially identify novel, highly predictive biomarkers.

Existing evidence suggests that both TST and IGRA are acceptable but imperfect tests, and that neither test can accurately differentiate between LTBI and active TB, distinguish reactivation from reinfection, or accurately predict progression from LTBI to active disease [19]. A recent meta-analysis [24] based on a combined sample size of 26 680 individuals and data derived from 15 longitudinal studies, concluded that neither IGRA nor TST accurately predict the risk of developing active TB, although the use of IGRAs in certain groups might reduce the number of people considered for chemoprophylaxis.

Overall, the current evidence suggests that the value of IGRAs for predicting progression to active TB disease is low and only marginally (non-significantly) higher than that of the TST [19]. There is also limited evidence suggesting that IGRA conversion detected using multiple testing may have a greater predictive value than single IGRA results as it may indicate recent infection [25]. With regard to high-risk populations (e.g. HIV-infected individuals) there are currently no data suggesting that IGRAs are better in predicting active TB in this group than the TST [19,26].

To conclude, evidence available to date suggests that both TST and IGRA have limited predictive values and their usefulness is restricted to identification of those who would potentially benefit from preventive therapy. Current and future studies will help establish the place and role of IGRAs in TB clinical and laboratory management and potentially identify novel, highly predictive biomarkers.

3.3.4 IGRA performance and reproducibility

Performance characteristics (sensitivity and specificity) of the two IGRAs currently available on the market (QFT-G and the T-SPOT) have recently been extensively reviewed [19,27,28]. In the absence of a gold standard, surrogate

markers are used to estimate performance characteristics. Specificity of both assays (>95%) is not affected by BCG vaccination and is similar to that of the TST in non-BCG-vaccinated individuals; in populations where BCG vaccination is administered, specificity of TST is significantly lower (60%). Existing evidence suggests that sensitivity of T-SPOT is slightly higher (~90%) than that of QFT-G (~80%) and is usually lower in children and immunocompromised individuals.

IGRAs have certain reproducibility issues and variability can be due to natural sources (immunomodulation and functionality of T-cells), manufacturing issues, pre-analytical and analytical deviations. This may require the reconsideration of cut-off values and the introduction of borderline zones (especially for the QFT-G assay) which might help to improve the reproducibility and diagnostic value of the assays [19].

3.3.5 Procedure 1: QuantiFERON-TB Gold and QuantiFERON-TB Gold PLUS

The QuantiFERON-TB Gold (QFT-G) and QuantiFERON-TB Gold PLUS (QFT-GP) made by Qiagen GmbH, Hilden, Germany)¹.

General principles

The QuantiFERON-TB Gold IT system uses blood collection tubes that contain antigens representing specific *M. tuberculosis* proteins or controls. After blood collection (nil control, TB antigen and a mitogen tube for QFT-G and nil control, two antigen tubes, and a mitogen tube for QFT-GP), tube incubation at 37°C ± 1°C for 16 to 24 hours follows. When incubation is complete, the tubes are centrifuged, plasma is harvested and the amount of IFN-γ produced is measured by ELISA. Results for test samples are reported in International Units (IU) relative to a standard curve prepared by testing dilutions of the secondary standard supplied by the manufacturer. The effect of heterophile antibodies is minimised by adding normal mouse serum to the green diluent and using F(ab')₂ monoclonal antibody fragments as the IFN-γ capture antibody coated to the microplate wells.

Baseline epidemiological data

Before performing the QuantiFERON-TB Gold IT test, baseline epidemiological data should be recorded: name, full address, contact information, gender, occupation, place of birth, time since immigration (if applicable), travel history, history of BCG vaccination and TST, clinical data (medication uptake, immunosuppression, weight loss, night sweats, fever, cough, abnormal chest X-ray (CXR), previous TB treatment/chemoprophylaxis, etc.). Baseline data should be recorded on the patient data sheet that accompanies the specimen (see Chapter 3, Annex 2).

Safety

Care should be taken when handling materials of human origin. All blood samples should be considered potentially infectious. Handling of blood samples and assay components, their use, storage and disposal should be in accordance with procedures defined in appropriate national, state or local biohazard and safety guidelines or regulations. Eye protection, gloves and normal laboratory protective clothing should be worn. Correct laboratory procedures should be adhered to at all times.

Materials provided by the manufacturer

Blood collection tubes QFT-G:

- Nil control (grey cap with white ring);
- TB antigen (red cap with white ring);
- Mitogen control (purple cap with white ring);
- QFT-GP;
- Nil control (grey cap with white ring);
- TB 1 antigen (green cap with white ring);
- TB 2 antigen (yellow cap white ring);
- Mitogen control (purple cap with white ring);
- ELISA components;
- Microplate strips coated with murine anti-human IFN-γ monoclonal antibody;
- Human IFN-γ standard, lyophilised (8 IU/ml when reconstituted; contains recombinant human IFN-γ, bovine casein, 0.01 % w/v thimerosal);

¹ Descriptions of laboratory procedures are based on the manufacturer's recommendations (Qiagen) and international safety, quality control and laboratory management regulations. The QuantiFERON-TB Gold package insert is available at: <https://www.quantiferon.com/products/quantiferon-tb-gold/package-inserts>

- Green diluent (contains bovine casein, normal mouse serum, 0.01% w/v thimerosal);
- Conjugate 100x concentrate, lyophilised (murine anti-human IFN- γ HRP, contains 0.01% w/v thimerosal);
- Wash buffer 20x concentrate (pH 7.2, contains 0.01 % w/v thimerosal);
- Enzyme substrate solution (contains H₂O₂, 3,3',5,5' tetramethylbenzidine);
- Enzyme stopping solution (contains 0.5M H₂SO₄).

Required materials (not provided)

- 37°C \pm 1°C incubator (with or without CO₂);
- Calibrated variable-volume pipettes for delivery of 10 μ l to 1 000 μ l with disposable tips;
- Calibrated multichannel pipette capable of delivering 50 μ l and 100 μ l with disposable tips;
- Centrifuge capable of centrifuging the blood tubes at least to 3 000 RCF (g);
- Microplate shaker capable of speeds between 500 and 1 000 rpm;
- Deionised or distilled water: 2 l;
- Microplate washer (for safety reasons, an automated washer is recommended);
- Microplate reader fitted with 450 nm filter and 620nm to 650 nm reference filter;
- Variable speed vortex;
- Timer;
- Measuring cylinder: 1 or 2 l;
- Reagent reservoirs.

Storage

- Blood collection tubes: store blood collection tubes at 4°C to 25°C (40°F to 77°F).
- ELISA kit reagents: store kit at 2°C to 8°C (36°F to 46°F). Always protect enzyme substrate solution from direct sunlight.
- Reconstituted and unused reagents: the reconstituted kit standard may be kept for up to three months if stored at 2°C to 8°C. Note the date on which the kit standard was reconstituted.
- The reconstituted 100x conjugate concentrate must be returned to storage at 2°C to 8°C and must also be used within three months. Note the date the 100x conjugate was reconstituted.
- Working strength conjugate must be used within six hours of preparation.
- Working strength wash buffer may be stored at room temperature for up to two weeks.

Methods

Sample collection and handling

- The contents of the tubes should be thoroughly mixed with the blood. Incubation at 37°C \pm 1°C should begin as soon as possible and within 16 hours of collection. For best results, the following procedures should be followed:
- For each subject collect 1 ml of blood by venipuncture directly into each of the QuantiFERON-TB Gold IT blood collection tubes. If the level of blood in any tube is not close to the indicator line, it is recommended that another blood sample be obtained. Under- or over-filling of the tubes outside of the 0.8 to 1.2 ml range may lead to erroneous results. High altitude (HA) tubes should be used at altitudes between 1 000 and 2 000 meters. Blood can also be collected using a syringe and 1 ml transferred to each of the three tubes, ensuring appropriate safety procedures. Alternatively, blood may be collected in a single generic blood collection tube and then transferred to QFT tubes. The generic collection tube must only contain lithium heparin as an anticoagulant, other anticoagulants such as EDTA may interfere with the assay.
- Thorough mixing is required to ensure complete integration of the tube's contents into the blood. Mix the tubes by shaking vigorously for five seconds (10 times).
- Label the tubes appropriately.
- Prior to incubation, maintain tubes at room temperature (22°C \pm 5°C). Do not refrigerate or freeze the blood samples.
- Perform specific tasks within set times.

Stage One: Incubation of blood and harvesting of plasma

- The tubes will have to be re-mixed if the blood is not incubated immediately after collection.
- Incubate the tubes upright at 37°C \pm 1°C for 16 to 24 hours. No CO₂ or humidification incubator is required.
- Following incubation, blood collection tubes may be held between 2°C and 27°C for up to three days prior to centrifugation.
- After incubation, centrifuge tubes for 15 minutes at 2 000 to 3 000 RCF (g). If the cells are not separated from the plasma by the gel plug, the tubes should be re-centrifuged at a higher speed.
- Plasma samples can be loaded directly from blood collection tubes into the ELISA plate.

- Alternatively, plasma samples can be stored prior to ELISA, either in the centrifuged tubes or collected into plasma storage containers. Plasma samples can be stored for up to 28 days at 2°C to 8°C or below -20°C (preferably less than -70°C) for extended periods.

Stage Two: Human IFN- γ ELISA

- Before use, plasma samples and reagents, except for conjugate 100x concentrate, must be brought to room temperature (22°C \pm 5°C). Allow at least 60 minutes for equilibration.
- Allow at least two strips on the ELISA frame for the standards and sufficient strips for the number of subjects being tested. Remove strips that are not required from the ELISA frame, reseal in the foil pouch, and return to the refrigerator for storage.
- Reconstitute the human interferon- γ kit standard with the indicated volume of deionised or distilled water (see label; concentration of 8.0 IU/ml). Use the reconstituted kit standard to produce a dilution series of four IFN- γ concentrations (4.0, 1.0, 0.25, 0 IU/ml). Green diluent serves as the zero standard.
- Reconstitute dried conjugate 100x concentrate with 0.3 ml of deionised or distilled water. Mix gently to ensure complete solubilisation. Working strength conjugate is prepared by diluting the required amount of reconstituted conjugate 100x concentrate in green diluent as set out in the package insert. Working strength conjugate should be used within six hours of preparation.
- Prior to assay, mix plasmas thoroughly.
- Add 50 μ l of freshly prepared working strength conjugate to each ELISA well.
- Add 50 μ l of test plasma samples to appropriate wells. Add 50 μ l each of the standards 1 to 4. The standards should be assayed at least in duplicate (triplicate preferred).
- Mix the conjugate and plasma samples/standards thoroughly using a microplate shaker for one minute at 500 to 1 000 rpm.
- Cover each plate and incubate at room temperature (22°C \pm 5°C) for 120 \pm 5 minutes. Plates should not be exposed to direct sunlight during incubation. Deviation from specified temperature range can lead to erroneous results.
- During incubation, dilute one part wash buffer 20x concentrate with 19 parts deionised or distilled water and mix thoroughly. Wash wells with 400 μ l of working strength wash buffer. Perform the wash step at least six times. An automated plate washer is recommended for safety reasons when handling plasma samples.
- Thorough washing is very important to the performance of the assay. When an automated plate washer is used, standard laboratory disinfectant should be added to the effluent reservoir, and established decontamination procedures for potentially infectious material should be followed.
- Tap the plates face down on absorbent towel to remove residual wash buffer. Add 100 μ l of enzyme substrate solution to each well and mix for one minute at 500 to 1 000 rpm using a microplate shaker.
- Cover each plate with a lid and incubate at room temperature (22°C \pm 5°C) for 30 minutes. Plates should not be exposed to direct sunlight during incubation.
- Following the 30-minute incubation, add 50 μ l of enzyme-stopping solution to each well and mix thoroughly. Enzyme-stopping solution should be added to wells in the same order and at approximately the same speed as the substrate in step 11.
- Measure the optical density (OD) of each well within five minutes of stopping the reaction using a microplate reader fitted with a 450 nm filter and with a 620 nm to 650 nm reference filter. OD values are used to calculate results.

Report interpretation

The predictive value of QFT-G results depends on the prevalence of *M. tuberculosis* infection in the tested population. Each QFT-G result and its interpretation should be considered in conjunction with other epidemiological, historical, physical, and diagnostic findings. The magnitude of the measured IFN- γ level cannot be correlated to stage or degree of infection, level of immune responsiveness, or likelihood for progression to active disease. Actual test data should not be reported. QuantiFERON-TB Gold IT results are interpreted using the following criteria (Tables 5 and 6).

Table 5. QuantiFERON-TB Gold results interpretation

TB antigen minus Nil (IU/ml)	Nil (IU/ml)	Mitogen minus Nil (IU/ml)	QuantiFERON-TB Gold IT Result	Report/interpretation
<0.35 or ≥0.35 and <25% of Nil value	≤8.0	≥0.5	Negative	MTB infection NOT likely
≥0.35 and ≥ 25% of Nil value	≤8.0	Any	Positive	MTB infection likely
<0.35 or ≥0.35 and <25% of Nil value	≤8.0	<0.5	Indeterminate	Results cannot be interpreted as a result of low mitogen response
Any	>8.0	Any	Indeterminate	Results cannot be interpreted as a result of high background response

Table 6. QuantiFERON-TB Gold PLUS results interpretation

Nil (IU/ml)	TB1 minus Nil or TB2 minus Nil (IU/ml)	Mitogen minus Nil (IU/ml)*	QFT-Plus Result	Report/interpretation
≤8.0	≥0.35 and ≥ 25% of Nil	Any	Positive	<i>M. tuberculosis</i> infection likely
≤8.0	<0.35	≥0.5	Negative	<i>M. tuberculosis</i> infection NOT likely
≤8.0	≥0.35 and <25% of Nil	≥0.5	Negative	<i>M. tuberculosis</i> infection NOT likely
≤8.0	<0.35	<0.5	Indeterminate	Results are indeterminate for TB- antigen responsiveness
≤8.0	≥0.35 and <25% of Nil	<0.5	Indeterminate	Results are indeterminate for TB- antigen responsiveness
>8.0	Any	Any	Indeterminate	Results are indeterminate for TB- antigen responsiveness

Limitations

- Diagnosis of LTBI means TB disease must be excluded by medical evaluation.
- A negative result must be considered in conjunction with the individual's medical and historical data, particularly for individuals with impaired immune function.
- There are technical factors related to indeterminate results:
 - Longer than 16 hours from blood drawing to incubation at 37°C ± 1°C;
 - Storage of filled blood collection tubes outside the recommended temperature range (22°C ± 5°C) prior to 37°C ± 1°C incubation;
 - Insufficient mixing of blood collection tubes; and
 - Incomplete washing of the ELISA plate.

If technical issues are suspected with the collection or handling of blood samples, the entire QuantiFERON-TB Gold IT test should be repeated. Please note that responses to the mitogen positive control (and occasionally TB antigen) can be outside the range of the microplate reader. This has no impact on test results.

Quality control

Internal quality assessment (IQA)

Test accuracy depends on the generation of an accurate standard curve. Results derived from the standards must be examined before test sample results can be interpreted. Each laboratory should determine appropriate types of control materials and frequency of testing in accordance with local, regional, national, or other applicable accrediting organisations (e.g. positivity rate, indeterminate rate).

Quality control parameters

- The mean OD value for standard 1 must be ≥ 0.600 ;
- The mean OD value for the zero standard (green diluent) should be ≤ 0.150 ;
- The % coefficient of variation (% CV) between replicates for standards 1 and 2 must be $\leq 15\%$;
- Replicate OD values for standards 3 and 4 must not vary by more than 0.040 optical density units from their mean;
- The correlation coefficient (r) calculated from the mean absorbance values of the standards must be ≥ 0.98 ;
- If the above criteria are not met, the run is invalid and must be repeated.

External quality assessment

Extensive quality management, including both internal and external quality assessment (EQA), is a keystone of TB laboratory diagnosis and is essential for the laboratory accreditation. The UK National External Quality Assessment Service (UK NEQAS, www.ukneqas.org.uk) has recently established an EQA scheme for QuantiFERON-TB Gold tests, which is also available for customers outside the UK. Qiagen offers the QFT-G test panel (Cat No 0594-0805), comprising three sets of interferon-gamma (IFN- γ) controls made up of recombinant human IFN- γ . Each complete set consists of three individual controls representing different IFN- γ concentration levels (levels 1, 2, and 3) within the linear range of QuantiFERON assays. New schemes are being developed based on previous experience [15,16] and should be established as soon as possible.

3.3.6 Procedure 2: T-SPOT procedure²

General principles

T-SPOT (Oxford Immunotec, Abingdon, UK), unlike QuantiFERON-TB Gold, uses an enzyme-linked immunospot (ELISPOT) technique based on enumeration of activated specific T-cells responding to stimulation by specific antigens (ESAT-6 and CFP10) and resulting in IFN- γ secretion. Stimulation by ESAT-6 and CFP10 antigens takes place in separate microtitre plate wells.

During the course of the procedure, peripheral blood mononuclear cells (PBMCs) are separated from a whole blood sample and counted so that a standardised cell number is used in the assay. The PBMCs are incubated with the antigens to allow stimulation of any sensitised T-cells present; secreted IFN- γ is captured by specific antibodies on the membrane at the base of the well. A second antibody, conjugated to alkaline phosphatase and directed to a different epitope on the (cytokine) IFN- γ molecule, is then added and binds to the cytokine captured on the membrane surface. Finally, a soluble substrate is added to each well; this is cleaved by bound enzyme to form a spot of insoluble precipitate at the site of the reaction. Each spot therefore represents the footprint of an individual cytokine-secreting T-cell, and evaluating the number of spots obtained provides a measurement of the abundance of *M. tuberculosis*-sensitive effector T-cells in the peripheral blood.

Baseline epidemiological data

As for the QuantiFERON-TB Gold assay, baseline epidemiological data are necessary for the correct clinical interpretation of the test results. Data should include name and surname, full address, contact information, gender, occupation, place of birth, time since immigration (if applicable), travel history, history of BCG vaccination and TST, relevant clinical data (medication uptake, immunosuppression, weight loss, night sweats, fever, cough, abnormal CXR, previous TB treatment/chemoprophylaxis, etc.). Baseline data should be recorded on the patient data sheet that accompanies the specimen (see Chapter 3, Annex 2).

Safety

This diagnostic procedure involves the handling of human blood samples and plasma, potentially infected with blood-borne infections, including HIV, hepatitis B, and hepatitis C. Protective equipment (gloves, lab coats and goggles or shields) should be worn when handling blood/plasma specimens. Handling, storage and disposal of blood specimens should be in accordance with national, state or local biohazard and safety guidelines or regulations. Risk assessment should be performed prior to introduction of the procedures and standard operating procedures should be developed and regularly updated.

² Descriptions of laboratory procedures are based on the manufacturer's recommendations (Oxford Immunotec) and international safety, quality control and laboratory management regulations.

The Oxford Immunotec T-SPOT.TB96 package insert is available at: <http://www.oxfordimmunotec.com/north-america/wp-content/uploads/sites/2/TG-TB-US-V5.pdf>

Important notes

- T-SPOT assay involves human PMBC cultivation. Therefore, it is extremely important to use an aseptic technique in order to avoid contamination of reagents, wells, cell cultures, and nourishing media;
- Blood should be progressed into the assay within eight hours of collection. This time can be prolonged by using the T-cell *Xtend* reagent (also available from Oxford Immunotec). In this case the sample storage time before assay is increased to 32 hours. Only lithium-heparine tubes can be used in conjunction with T-cell *Xtend*;
- Calculations for the conjugate dilution, cell counting, etc. are provided on the CD-ROM supplied along with the kits.

Materials

Provided by the manufacturer with the kits (Table 7).

Table 7. Materials provided by the manufacturer

	T-SPOT TB 96 kit	T-SPOT TB 8 kit
1	One microtitre plate: 96 wells coated with a mouse monoclonal antibody to IFN- γ .	One microtitre plate: 96 wells, supplied as 12x8-well strips in a frame, coated with a mouse monoclonal antibody to IFN- γ
2	Two vials (0.7 ml each) Panel A: contains ESAT-6 antigens	Two vials (0.8 ml each) Panel A: contains ESAT-6 antigens
3	Two vials (0.7 ml each) Panel B: contains CFP10 antigens	Two vials (0.8 ml each) Panel B: contains CFP10 antigens
4	Two vials (0.7 ml each) Positive control: contains phytohaemagglutinin (PHA)	Two vials (0.8 ml each) Positive control: contains phytohaemagglutinin (PHA)
5	One vial (50 μ l) 200x concentrated conjugate reagent: mouse monoclonal antibody to IFN- γ conjugated to alkaline phosphatase.	One vial (50 μ l) 200x concentrated conjugate reagent: mouse monoclonal antibody to IFN- γ conjugated to alkaline phosphatase
6	One bottle (25 ml) substrate solution: ready to use BCIP/NBT (plus) solution.	One bottle (25 ml) substrate solution: ready to use BCIP/NBT (plus) solution.

All reagents except the conjugate are supplied ready to use. The conjugate should be diluted with PBS 1:200 immediately prior to use (50 μ l working strength solution per well).

Equipment and materials required but not provided with the kits:

- Class II microbiological cabinet (recommended to observe aseptic technique);
- Centrifuge for preparation of PBMCs (capable of at least 1800xg and able to maintain the samples at room temperature (18–25°C));
- Haemocytometer;
- Inverted microscope (e.g. Wilovert S, Wetzlar, Germany);
- A humidified incubator capable of 37 \pm 1°C with a 5% CO₂ supply;
- A microtitre plate washer or equipment to manually wash plates (e.g. multichannel pipette);
- Pipettes and sterile pipette tips;
- Instruments for the plate reading: Microscope, or digital microscope, or magnifying glass, or plate imager (e.g. ELR02, Autoimmun Diagnostika GmbH, Germany).

Consumables:

- Sterile pipette tips;
- Blood collection tubes with heparin or sodium citrate (such as Vacutainer CPT). EDTA tubes are NOT recommended.

Reagents:

- Ficoll-Paque* PLUS or alternative PBMC separation materials;
- Trypan blue dye (available from Sigma, catalogue number T8154);
- Sterile PBS solution, available from Invitrogen as 'GIBCO Dulbecco's Phosphate-Buffered Saline (D-PBS) (1x)', catalogue number 14040-091). Do not use PBS containing Tween;
- Distilled or deionised water;
- Sterile serum-free cell culture medium such as 'GIBCO AIM V' (Invitrogen; catalogue number 31035-025) (for incubation);
- Sterile cell culture medium RPMI 1640 (Invitrogen; catalogue number 21875-034) (for initial cell preparation and cell suspension dilution).

Sample collection

Blood should be collected as follows:

- Adults and children 10 years old and over: one 8 ml or two 4 ml CPT tubes or one 6 ml lithium heparin tube.
- Children aged two to 9 years: one 4 ml CPT or lithium heparin tube.
- Children aged up to two years: one 2 ml paediatric tube.
- After collection, blood should be stored at room temperature (no refrigeration or freezing) and assayed within eight hours. This can be prolonged to 32 hours if T-Cell *Xtend* is used. The T-Cell *Xtend* reagent should be added prior to PBMC separation using standard separation techniques. Whole blood samples should be stored at room temperature (18–25°C) between 23 and 30 hours post-venipuncture with the use of T-Cell *Xtend* reagent.
- If the T-Cell *Xtend* reagent is to be used, immediately before cell separation remove the cap from the blood collection tube and add 25 µl of the T-Cell *Xtend* reagent solution per ml of blood sample.
- Replace the cap and invert the blood collection tube gently eight to 10 times to mix. Incubate for 20 ± 5 minutes at room temperature (18–25°C) and then proceed to isolate the PBMC layer using Ficoll density gradient centrifugation.

Sample preparation

Initial sample preparation steps depend on whether Vacutainer CPT or conventional Lithium-heparin or sodium citrate tubes were used for the blood collection. Please note that T-Cell *Xtend* reagent is NOT compatible with the CPT tubes. Leucosep tubes are now validated for use with the T-SPOT.TB assay, and can be used with T-Cell *Xtend* simplifying Ficoll preparation of peripheral blood mononuclear cells (PBMCs). The Leucosep tube eliminates the time-consuming and laborious layering of the sample material over FICOLL-PAQUE PLUS. For details of the specimen preparation procedures involving T-Cell *Xtend*, please refer to the T-SPOT TB Technical handbook: <http://www.oxfordimmunotec.com/international/wp-content/uploads/sites/3/TG-TB-UK-V4.pdf>.

CPT tubes (with gel plug)

- Centrifuge 8 ml CPT tubes at 1600xg for 28 minutes or 4 ml CPT tubes at 1800xg for 30 minutes at 18°C if a refrigerated centrifuge is available. If a non-refrigerated centrifuge is used, ensure the temperature does not go above 25°C;
- Collect the white, cloudy band of PBMCs using a pipette and transfer to a 15 ml conical centrifuge tube. Make up the volume to 10 ml with cell culture medium AIM V or RPMI 1640.

Lithium-heparin/sodium citrate tubes

- Dilute the blood with an equal volume of RPMI 1640 medium. Carefully layer the diluted blood (2–3 volumes) onto Ficoll-Paque PLUS (1 volume) and centrifuge at 1 000xg for 22 minutes while maintaining the temperature between 18 and 25°C.
- Collect the white, cloudy band of PBMCs using a pipette and transfer to a 15 ml conical centrifuge tube. Make up the volume to 10 ml with cell culture medium AIM V or RPMI 1640.
- Centrifuge at 600xg for seven minutes. Pour off the supernatant and re-suspend the pellet in 1 ml AIM V or RPMI medium.
- Make up the volume to 10 ml with fresh AIM V or RPMI medium and centrifuge at 350g for seven minutes.
- Pour off the supernatant and resuspend the pellet in 0.7 ml AIM V culture medium.

Cell counting and dilution

- The T-SPOT.TB assay requires 2.5 x 10⁵ viable PBMCs per well. A total of four wells are required for each patient sample. The correct number of cells must be added to each well. Failure to do so may lead to an incorrect interpretation of the result. Care should be taken to ensure that the cell suspension is thoroughly mixed immediately prior to removal of aliquots for dilution or for counting.
- For manual counting with a Neubauer haemocytometer, add 10 µl of the final cell suspension to 40 µl 0.4% (w/v) trypan blue solution. Place an appropriate aliquot onto the haemocytometer and count the cells in the grid. For other types of haemocytometers and for automated devices, follow the manufacturer's instructions.
- Calculate the concentration of viable cells present in the stock cell suspension. The T-SPOT cell dilution calculator on the CD-ROM provided with each assay kit will facilitate this calculation.
- Prepare 500 µl of the final cell suspension at a concentration of 2.5x10⁵ cells/100 µl. Ensure cells are thoroughly mixed before removing an aliquot for dilution.

Plate set up and incubation

The T-SPOT.TB assay requires four wells to be used for each patient sample. A nil control and a cell functionality positive control should be run with each individual sample. It is recommended that the samples are arranged vertically on the plate as illustrated below:

- Nil control
- Panel A
- Panel B
- Positive control

- Remove the pre-coated microtitre plate from the packaging and allow to equilibrate to room temperature. The microtitre plate is provided with a protective plastic base. This should not be removed at any stage of the procedure.
- Each patient sample requires the use of four individual wells as follows. (Do not allow the pipette tip to touch the membrane. Indentations in the membrane caused by pipette tips may cause artefacts in the wells).
 - Add 50 µl AIM V culture medium to each nil control well.
 - Add 50 µl Panel A solution to each well required.
 - Add 50 µl Panel B solution to each well required.
 - Add 50 µl positive control solution to each positive control well.
- To each of the four wells to be used for a patient sample, add 100 µl of the patient's final cell suspension (containing 250 000 viable cells).
- Incubate the plate in a humidified incubator at 37°C with 5% CO₂ for 16 to 20 hours.

Spot development and counting

- Remove the plate from the incubator and discard the cell culture medium. Remove the substrate solution from the kit and allow to equilibrate to room temperature.
- Add 200 µl PBS solution to each well.
- Discard the PBS solution. Repeat the well washing a further three times with fresh PBS solution for each wash. Discard all PBS from the final wash step by inverting the plate on absorbent paper before proceeding.
- Dilute the concentrated conjugate reagent 1:200 in PBS to create the working strength solution.
- Add 50 µl working strength conjugate reagent solution to each well and incubate at 2–8°C for one hour.
- Discard the conjugate and perform four PBS washes as described in steps 2 and 3 above.
- Add 50 µl substrate solution to each well and incubate at room temperature for seven minutes.
- Wash the plate thoroughly with distilled or deionised water to stop the detection reaction. Allow the plate to dry by standing it in a well-ventilated area or in an oven at up to 37°C (spots become more visible as the plate dries). Allow four hours drying time at 37°C or overnight at room temperature.
- Count and record the number of distinct, dark blue spots on the membrane of each well. Use a magnifying glass, a suitable microscope, or an ELISPOT plate reader.
- Apply the results interpretation and assay criteria (see below) to determine whether a patient sample is 'positive' or 'negative' to TB antigens.

Reading and results interpretation

T-SPOT.TB results are interpreted by subtracting the spot count in the nil control well from the spot count in each of the panels, according to the following algorithm:

- The test result is 'positive' if (Panel A minus nil control) and/or (Panel B minus nil control) ≥ 6 spots, AND a nil control count < 10 spots;
- The test result is 'negative' if both (Panel A minus nil control) and (Panel B minus nil control) ≤ 5 spots (this includes values less than zero), AND a nil control count < 10 spots AND a positive control count > 20 spots (or show saturation);
- The test result is 'indeterminate' if:
 - a nil control count > 10 spots regardless of spot counts in Panel A and Panel B; or
 - a positive control count < 20 spots if both (Panel A minus nil control) and (Panel B minus nil control) ≤ 5 spots.

Due to potential biological and systematic variations, where the highest of Panel A minus nil control and Panel B minus nil control is five, six, or seven spots, the result may be considered as borderline (equivocal). Borderline (equivocal) results, although valid, are less reliable than results where the spot count is further from the cut-off. Retesting of the patient, using a new sample, is therefore recommended. If the result is still borderline (equivocal)

on retesting, then other diagnostic tests and/or epidemiological information should be used to help determine TB infection status of the patient.

Reporting

The manufacturer recommends using the following wording in the laboratory reports:

- A 'positive' result indicates that the sample contains effector T-cells reactive to *M. tuberculosis*.
- A 'negative' result indicates that the sample probably does not contain effector T-cells reactive to *M. tuberculosis*.

Quality control

Internal quality assessment (IQA)

Appropriate means of internal quality assurance and control should be determined, developed and implemented by each laboratory in accordance with local and governmental regulations. This can include:

- blind re-testing of specimens on a regular basis;
- keeping records on dates when kits are opened and finished, kit lot numbers;
- fridge and freezer temperature sheets.

External quality assessment (EQA)

No formal EQA schemes for T-SPOT TB tests currently exist. These should be established and implemented as soon as possible based on previous experience.

References

1. Tufariello JM, Chan J, Flynn JL. Latent tuberculosis: mechanisms of host and bacillus that contribute to persistent infection. *Lancet Infect Dis*. 2003 Sep;3(9):578-90.
2. Dye C, Scheele S, Dolin P, Pathania V, Raviglione MC. Consensus statement. Global burden of tuberculosis: estimated incidence, prevalence, and mortality by country. WHO Global Surveillance and Monitoring Project. *JAMA*. 1999 Aug 18;282(7):677-86.
3. Styblo K. The relationship between the risk of tuberculosis infection and the risk of developing infectious tuberculosis. *Bull Int Union Tuberc*. 1985;60:117-9.
4. Flynn JL, Chan J. Immunology of tuberculosis. *Annu Rev Immunol*. 2001;19(1):93-129.
5. World Health Organization (WHO). The Stop TB Strategy: Building on and enhancing DOTS to meet the TB-related Millennium Development Goals. Geneva: WHO; 2006. Available at: http://apps.who.int/iris/bitstream/handle/10665/69241/WHO_HTM_STB_2006.368_eng.pdf
6. Lee E, Holzman RS. Evolution and current use of the tuberculin test. *Clin Infect Dis*. 2002 Feb 1;34(3):365-70.
7. Harboe M, Oettinger T, Wiker HG, Rosenkrands I, Andersen P. Evidence for occurrence of the ESAT-6 protein in *Mycobacterium tuberculosis* and virulent *Mycobacterium bovis* and for its absence in *Mycobacterium bovis* BCG. *Infect Immun*. 1996 Jan;64(1):16-22.
8. Behr MA. Comparative genomics of BCG vaccines. *Tuberculosis (Edinb)*. 2001;81(1-2):165-8.
9. Andersen P, Munk ME, Pollock JM, Doherty TM. Specific immune-based diagnosis of tuberculosis. *Lancet*. 2000 Sep 23;356(9235):1099-104.
10. Andersen P, Doherty TM, Pai M, Weldingh K. The prognosis of latent tuberculosis: can disease be predicted? *Trends Mol Med*. 2007 May;13(5):175-82.
11. Pai M. Guidelines on IGRAs: Concordant or discordant? 2nd Global Symposium on IGRAs, May 30–June 1, 2009. Dubrovnik, Croatia.
12. Nyendak MR, Lewinsohn DA, Lewinsohn DM. New diagnostic methods for tuberculosis. *Curr Opin Infect Dis*. 2009 Apr;22(2):174-82.
13. Mazurek GH, Jereb J, Lobue P, Iademarco MF, Metchock B, Vernon A. Guidelines for using the QuantiFERON-TB Gold test for detecting *Mycobacterium tuberculosis* infection, United States. *MMWR Recomm Rep*. 2005 Dec 16;54(RR-15):49-55. Erratum in: *MMWR Morb Mortal Wkly Rep*. 2005 Dec 23;54(50):1288.
14. National Collaborating Centre for Clinical Conditions. Royal College of Physicians. Tuberculosis: clinical diagnosis and management of tuberculosis, and measures for its prevention and control. London: Royal College of Physicians; 2006. Available at: <https://www.nice.org.uk/guidance/cg117/documents/tuberculosis-interferon-gamma-tests-update-partial-update2>
15. Westgard JO, Barry PL, Hunt MR, Groth T. A multi-rule Shewhart chart for quality control in clinical chemistry. *Clin Chem*. 1981 Mar;27(3):493-501.
16. Hang NT, Ishizuka N, Keicho N, Hong LT, Tam DB, Thu VT, et al. Quality assessment of an interferon-gamma release assay for tuberculosis infection in a resource-limited setting. *BMC Infect Dis*. 2009 May 18;9:66.
17. Kaufmann SH. How can immunology contribute to the control of tuberculosis? *Nat Rev Immunol*. 2001 Oct;1(1):20-30.
18. Denkinger CM, Dheda K, Pai M. Guidelines on interferon- γ release assays for tuberculosis infection: concordance, discordance or confusion? *Clin Microbiol Infect*. 2011 Jun;17(6):806-14.
19. Pai M, Denkinger CM, Kik SV, Rangaka MX, Zwerling A, Oxlade O, et al. Gamma interferon release assays for detection of *Mycobacterium tuberculosis* infection. *Clin Microbiol Rev*. 2014 Jan;27(1):3-20.
20. European Centre for Disease Prevention and Control (ECDC). Use of interferon-gamma release assays in support of TB diagnosis. Stockholm: ECDC; 2011. Available at: <https://ecdc.europa.eu/publications-data/public-health-guidance-use-interferon-gamma-release-assays-support-tb-diagnosis>
21. World Health Organization (WHO). Guidelines for intensified tuberculosis case-finding and isoniazid preventive therapy for people living with HIV in resource-constrained settings. Geneva: WHO; 2011. Available at: <http://www.who.int/hiv/pub/tb/9789241500708>
22. World Health Organization (WHO). Use of tuberculosis interferon-gamma release assays (IGRAs) in low-and middle- income countries: policy statement. Geneva: WHO; 2011. Available at: <http://www.who.int/tb/publications/tb-igras-statement>
23. World Health Organization (WHO). Guidelines on the management of latent tuberculosis infection. Geneva: WHO; 2015. Available at: <http://www.who.int/tb/publications/latent-tuberculosis-infection>
24. Rangaka MX, Wilkinson KA, Glynn JR, Ling D, Menzies D, Mwansa-Kambafwile J.. Predictive value of interferon-gamma release assays for incident active tuberculosis: a systematic review and meta-analysis. *Lancet Infect Dis*. 2012;12:45–55.
25. Machingaidze S, Verver S, Mulenga H, Abrahams DA, Hatherill M, Hanekom W, et al. Predictive value of

- recent QuantiFERON conversion for tuberculosis disease in adolescents. *Am. J. Respir. Crit. Care Med.* 2012;186:1051–1056.
26. Kim YJ, Kim SI, Kim YR, Wie SH, Park YJ, Kang MW.. Predictive value of interferon-gamma ELISPOT assay in HIV 1-infected patients in an intermediate tuberculosis-endemic area. *AIDS Res. Hum. Retroviruses* 2012; 28:1038–1043.
 27. Cattamanchi A, Smith R, Steingart KR, Metcalfe JZ, Date A, Coleman C, Marston BJ, Huang L, Hopewell PC, Pai M. Interferongamma release assays for the diagnosis of latent tuberculosis infection in HIV-infected individuals—a systematic review and meta-analysis. *J. Acquir. Immune Defic. Syndr.* 2011;56:230–238.
 28. Diel R, Loddenkemper R, Nienhaus A. Predictive value of interferon-gamma release assays and tuberculin skin testing for progression from latent TB infection to disease state: a meta-analysis. *Chest* 2012;142:63–75.

Annex 2. Patient data sheet

Sender's contact details: Name Laboratory/hospital Postal address

Phone Fax

For laboratory use

Patient's number

Date received

Time received

Date of test

Please circle/mark/tick appropriate answer(s). Please do not leave any fields blank. If answer requires further details, please specify.

Please remember that complete answers are essential for the correct interpretation of the test results.

Baseline epidemiological data

Patient's first name

Surname

Date of birth

Male ___ Female ___

Postcode

Occupation

Was the patient born abroad?

Yes ___

No ___ Born in _____

If no, when did the patient come to _____ (country)? _____ (year)

Has patient lived, or spent more than two months travelling in another country?

Yes ___

No ___

Don't know

History of BCG vaccination and TB skin tests

Has patient ever received a BCG vaccination? Yes ___ No ___ Don't know ___

If yes, please specify age: .

BCG scar: Yes ___ No ___

TB skin test done? Yes ___ No ___ Don't know ___ Reading ___ mm

Clinical data

Is patient taking any of the following medications?

___ Oral steroids

___ Cytotoxic drugs

___ Other immunosuppressive drugs (please specify)

___ None of the above.

Is the patient immunocompromised? Yes ___ No ___ Don't know ___

Is the patient HIV positive? Yes ___ No ___ Don't know ___

Does the patient have diabetes? Yes ___ No ___ Don't know ___

Does the patient have any of the following:

___ Fever

___ Night sweats

___ Loss of weight

___ Cough

Is the patient's CXR abnormal? Yes ___ No ___. If yes, please specify the location:

	R	L
Upper	_____	_____
Middle	_____	_____
Lower	_____	_____

Cavities? Yes ___ No ___ Don't know ___

Consolidation? Yes ___ No ___ Don't know ___. Unilateral/bilateral?

Other relevant clinical data:

4 Smear microscopy

Susana David, Vera Katalinić-Janković, Daniela Cirillo

Revised by Emanuele Borroni and Enrico Tortoli (2015)

4.1 Background and principles

Early laboratory diagnosis of TB still relies on the examination of stained smears. For universal application in resource-limited countries, microscopy of stained sputum smears is the best choice among diagnostic methods [7, 12]. This technique is based on the fact that the cell wall of the *Mycobacterium spp.* genus is rich in complex lipids that prevent access to common aniline dyes, but when stained with carbol-fuchsin or fluorochromes under special staining conditions, these are not easily decolourised, even with alcohol-acid solutions. Because of this characteristic, all members of *Mycobacterium spp.*, not only *M. tuberculosis*, are referred to as acid-fast bacilli (AFB).

At present, two types of acid fast stains are used to detect mycobacteria in clinical specimens:

- Carbol-fuchsin staining (Ziehl-Neelsen [ZN] method and its modification performed without heating the dye [Kinyoun cold staining]); and
- Fluorochrome (auramine or auramine-rhodamine) staining.

Kinyoun staining is a modification of the classic ZN staining which excludes the heating step during the staining procedure and uses a higher concentration of carbol-fuchsin. Mycobacteria appropriately stained by ZN and Kinyoun appear as red rods. Kinyoun staining is not as effective as ZN, therefore this procedure is not recommended [6].

Methods which apply a fluorochrome have been used to stain acid fast bacteria for many years. Using this method, mycobacteria are detected as bright fluorescent rods against a darker background. Fluorochrome staining has an increased sensitivity and less time is required to screen the slides when compared to Kinyoun or ZN staining because slides are screened at lower magnification [6].

Smear microscopy is simple, inexpensive and efficient in detecting those cases of pulmonary TB that are most infectious. Since its yield is highly dependent on its execution, the quality of smear microscopy is crucial in the fight against TB in resource-limited settings [6,7].

A major limitation of smear microscopy is its low sensitivity (25–75% compared to culture) and the high number of bacilli required for positivity (in the range of 5×10^3 – 10^4 bacilli per ml). Sensitivity and the positive predictive value (PPV) of smear microscopy are influenced by numerous factors [7,12,13] such as the prevalence and severity of the disease, the type and quality of the specimen, the number of mycobacteria in the sample and the quality of the smear preparation, staining and reading process. Smear microscopy does not allow for mycobacterial species identification, nor does it give an indication of the viability of mycobacteria in the sample. HIV co-infected TB patients may have disseminated paucibacillary disease with fewer AFB. Smear microscopy is often negative or may require more scrutiny in screening to identify lower numbers of AFB.

4.2 Procedure 1: Ziehl-Neelsen (ZN)

Each batch of prepared reagent should be recorded in a reagent preparation workbook which includes: the signature of the technician who prepared it, the date of preparation and the results of quality control testing [2,6].

4.2.1 Ziehl-Neelsen (ZN) reagent preparation

Good staining reagents, made with high-quality carbol-fuchsin dye are essential for detecting AFBs [6]. Contamination of reagents by environmental mycobacteria should be prevented by using freshly distilled water.

Standard reagents:

- Basic fuchsin powder
- Phenol crystals (the crystals should be almost colourless)
- Alcohol (denaturated 95% ethanol)
- Water (distilled or purified).

Decolourising solution:

- Concentrated sulphuric acid ($\geq 95\%$)
- Water (distilled or purified) or
- Hydrochloric acid (37%)

- Alcohol (denaturated 95% ethanol).

The counterstain solution:

- Methylene blue powder
- Water (distilled or purified).

A. Carbol-fuchsin (CF) reagent

The quality of basic fuchsin varies among different manufacturers with regard to its purity and solubility. The basic fuchsin content should represent 85–88% of the weight. If carbol-fuchsin purity is known, it should be used to calculate the final stain concentration of 0.3%. To calculate the required amount of basic fuchsin, divide the actual amount by the dye content. For instance, if the dye content is 75%, you must divide the amounts by 0.75. So $3\text{ g}/0.75 = 4$ grams will be weighed for the 0.3% stain. If powder with a dye content of >85% is used, there is no need to calculate the correction factor. If the dye purity is unknown or if the basic fuchsin dissolves poorly or precipitates are still visible after filtration, it may be wise to use the higher concentration (1%) when preparing the staining reagent.

0.3% Carbol-fuchsin	
Basic fuchsin	3.0 g
95% ethanol	100 ml
Phenol crystals	50 g
Distilled water	900 ml

- Weigh 3.0 g of basic fuchsin powder and 50 g of phenol crystals separately.
- Add 100 ml of alcohol (denaturated ethanol) to a 1-l conical flask.
- Add 50 g of phenol and swirl the flask until it is dissolved.
- Add 3.0 g of basic fuchsin powder and continue to mix well until the fuchsin powder completely dissolves.

Check for remaining powder or crystals on the bottom. If there are any, continue swirling with slight heating. Only after the fuchsin is completely dissolved, add 850 ml of water and mix by continuing to swirl.

If precipitates are visible, the carbol-fuchsin staining reagent should be filtered. Filter the carbol-fuchsin again during the staining process, using a funnel with filter paper (or by placing a piece of filter paper directly on the slide). Other staining reagents do not need to be filtered. If any particles are detected in the carbol-fuchsin solution, the solution must be refiltered.

B. Decolourising solution

25% sulphuric acid	
Concentrated sulphuric acid	250 ml
Distilled water	750 ml

- Add 750 ml of distilled water to a 2-l conical flask.
- Measure 250 ml of concentrated sulphuric acid in a cylinder.
- Pour it slowly into the flask containing the water, directing the flow of acid gently along the inner side of the flask. **Always add the acid slowly to the water, not vice versa.**
- Mix well by swirling the flask.

3% HCl ethanol	
Concentrated hydrochloric acid	30 ml
95% ethanol	970 ml

- Add 970 ml of 95% ethanol to a 2-l conical flask.
- Measure 30 ml of concentrated hydrochloric acid into a cylinder.
- Pour it slowly into the flask containing alcohol, directing the flow of acid gently along the inner side of the flask with constant swirling. **Always add the acid slowly to the alcohol, not vice versa.**
- Mix well by swirling.

C. Counterstain

Methylene blue chloride	3.0 g
Distilled water	1 000 ml

- Weigh 3 g of methylene blue powder.
- Add the powder to 0.5 l of pure water in a conical flask.
- Swirl the contents of the flask to dissolve the dye.
- Add 0.5 l of water and mix again.

4.2.2 Storage of reagents

The flasks of freshly-prepared reagents should be covered until quality control procedures have been performed and the results have been evaluated [7]. Solutions should be stored in clean brown bottles and clearly labelled. The label should indicate the reagent name, concentration, and the preparation date. Reagents preserved in tightly closed bottles can be used for up to one year. Bottles should be kept out of direct sunlight. If clear bottles are used, stocks of reagents should be stored in a closed cabinet.

4.2.3 Quality control of freshly-prepared staining reagents

After preparing staining reagents, quality control checks should be performed on every batch [7,14]. Quality control is essential to ensure the effectiveness of staining reagents and the complete absence of AFB contamination.

Quality control results should be recorded in a logbook, with every batch clearly identified by the name of the reagent and the preparation date on the bottle labels. Perform quality control by using one or more freshly-prepared staining reagents, carrying out the usual staining procedure as described for positive controls. Test the performance of cabol-fuchsin by staining and examining two scanty or 1+ smears stained once, and two negative smears stained three times [2].

4.3 Procedure 2: Fluorochrome staining

4.3.1 Quality control of freshly-prepared staining reagents

A. Fluorochrome reagents

Auramine O (solution 1)	
Auramine	0.1 g
95% ethanol	10 ml

Phenol (solution 2)	
Phenol crystals	3.0 g
Distilled water	87 ml

Dissolve phenol crystals in water.

Mix solutions 1 and 2 and store in a tightly stoppered, dark-coloured bottle away from heat and light. Label bottles with the name of the reagent, the date of preparation and expiry date. Store at room temperature for three months. When left standing turbidity may develop but this does not affect the staining reaction.

B. Decolourising solution

0.5% Acid alcohol	
Concentrated hydrochloric acid	0.5 ml
70% ethanol	100 ml

Carefully add concentrated hydrochloric acid to the ethanol. Always add acid slowly to the alcohol, not vice versa. Store in a dark-coloured bottle. Label bottles with the name of the reagent, the date of preparation and expiry date. Store at room temperature for three months. For each volume of stain, two to three volumes of decolourising solution are needed.

C. Counterstains

Either potassium permanganate or acridine orange may be used as counterstains.

Potassium permanganate	
Potassium permanganate (KmnO ₄)	0.5 g
Distilled water	100 ml

Dissolve potassium permanganate using distilled water in a tightly stoppered, dark-coloured bottle. Label bottles with the name of the reagent, the date of preparation and expiry date. Store at room temperature for up to three months.

Acridine orange	
Anhydrous dibasic sodium phosphate (Na ₂ HPO ₄)	0.01 g
Distilled water	100 ml

Acridine orange	0.01 g
-----------------	--------

Dissolve sodium phosphate in distilled water. Add acridine orange and mix until dissolved. Store in a tightly stoppered dark-coloured bottle away from heat and light. Label bottles with the name of the reagent, the date of preparation and expiry date. Store at room temperature for three months.

4.3.1 Safety measures

Never add water to acid. To reduce exposure to toxic phenolic fumes, reagents and staining solution containing phenol should be prepared in a well-ventilated area or under a chemical hood. Always wear protective laboratory coats, gloves and safety glasses when handling a strong acid. In the event of an accident with acid, rinse the affected body part immediately with plenty of water.

Sample collection

Smear microscopy for *Mycobacterium spp.* detection can be used for a wide variety of biological samples. For the diagnosis of respiratory TB, sputum is the most commonly used sample. To ensure optimal recovery of TB bacilli from sputum, at least two specimens should be collected and processed for mycobacterial microscopy and culture [7,15].

Country guidelines will provide information on the number of recommended samples. Early morning specimens have the highest yield of AFB; however, it is now proven that good diagnostic specimens can be collected at any time. It is not recommended to perform smear microscopy from blood or very bloody samples due to the low sensitivity of the procedure. It is also not recommended to routinely perform smear microscopy from urine samples due to the frequent detection of saprophytic mycobacteria colonising the urogenital tract.

Samples should be collected in clean, wide-mouthed and leak-proof specimen containers [2,6]. Single use disposable plastic containers (50 ml capacity) are preferred in order to avoid transferring the specimens from one container to another. Alternatively, 50 ml disposable sterile conical tubes can be used.

Patients should receive clear written instructions on the proper collection of the sputum specimen for TB diagnosis. For patients on treatment, specimens should be collected at intervals specified in accordance with the country's guidelines [7]. Sputum collection should never be performed in the laboratory. It is a procedure generating infectious aerosols and should only be performed at a distance from other people, preferably in open spaces where possible, or in rooms with negative pressure and adequate air exchange [7,14].

A good specimen should be approximately 3–5 ml in volume [5]. Sputum specimens should appear thick and mucoid or clear but with purulent grains [7]. The colour varies from opaque white to green. Bloody specimens will appear reddish or brown. Note: clear saliva or nasal discharge is not suitable as a TB specimen [2,15].

Specimen handling

For optimum patient management, process the specimen as soon as possible (i.e. < 24 hours). For microscopic examination, the interval between collection and staining is not critical. Acceptable results can be obtained even if specimen delivery has been delayed.

Criteria of acceptability

Upon arrival in the laboratory, the quality of sputum samples should be assessed and reported in the referral form [7]. TB-positive sputa can vary in colour and aspect. If the sample is liquid and is clear and water-like, without particles or streaks of mucous material, process the sample but ensure that the poor quality of the sample is reported on the result form. When possible, encourage the patient/physician to submit a new specimen; however, even saliva can yield positive results. All specimens should be processed except for broken or leaking containers, which should be discarded and another specimen requested.

Accept very small quantities if the patient has difficulty producing sputum. Blood-streaked sputum is suitable, but pure blood should not be examined [1,2].

4.5 Smear preparation

Although smear preparation for AFB detection [7] is a relatively safe procedure in terms of infected aerosol production, it is recommended that the slides be prepared in a class I or IIB biological safety cabinet [14,15] if available. If the smear is prepared after centrifugation of the sample (concentrated smear), the centrifuge holder must be opened within a biological safety cabinet.

- Smears should be prepared using new, clean, grease-free and unscratched slides. Using a pencil, record the laboratory register serial number and order number of the specimen on the frosted end of the slide. If plain unfrosted slides are used, label them using a diamond pencil.
- If smear is prepared directly from a fresh sample (without prior centrifugation) use an applicator stick or wire/disposable loop, select and pick up the yellowish purulent particles of sputum. For re-suspended pellets (after the centrifugation) a disposable loop is advisable.
- Prepare the smear in an oval shape in the centre of the slide. The smear size should be 2–3 cm in length and 1–2 cm wide, which will allow 100–150 fields to be counted in one length.
- For good spreading of the sputum, press the stick firmly perpendicular to the slide and move in small concentric circles or coil-like patterns.
- Place the used stick in a discard container.
- Use a separate stick for each specimen.
- Thorough spreading of the sample is very important, especially in the case of thick or purulent material; it should be neither too thick nor too thin. Prior to staining, hold the smear about 4–5 cm over a piece of printed paper. If letters cannot be read, it is too thick.
- For concentrated samples (after centrifugation at 3 000x g for 20 minutes, see sample preparation for TB culture) one or two drops of sediment should be smeared on the slide.
- Allow the smear to air-dry completely at room temperature within the biological safety cabinet.
- Do not dry smears in direct sunlight or over a flame.
- Pass the slide over a flame 2–3 times for about 2–3 seconds each time. Do not heat the slide for too long or keep it stationary over the flame or else the slide will be scorched.
- Alternatively, slides can be fixed for two hours on hot plates (65–75°C), within the biological safety cabinet. Table 8 lists the equipment needed for direct (unconcentrated) smear microscopy.

Table 8. Equipment required for smear preparation and staining

Equipment required for smear preparation and staining
Container to store specimen
Wire loop with an inner diameter of 3 mm to spread sputum on the slide
Microscope slide (grease-free and unscratched)
Marking pen to put the identification number on the microscopy slide
Forceps to hold smear slide
Bunsen burner to fix the smear slide and flame the smear during staining
Staining rack to hold the smear slide
Slide rack in which to place stained smear slide for air-drying

4.6 Staining procedures

4.6.1 Ziehl-Neelsen staining method

- Cover the entire surface of each heat-fixed slide with carbol-fuchsin.
- Using a Bunsen burner, gently heat the slides until vapour rises. Do not allow them to boil.
- Allow the stain to remain on the slide for ten minutes. Adequate time is required for the carbol-fuchsin to penetrate and stain the cell wall.
- Gently wash the stain from each slide with a stream of cold water until all the free stain has washed away.
- Cover each slide with acid alcohol; wait three minutes.
- Rinse slides again carefully with water and tilt each slide to remove excess water.
- Flood the slide with the methylene blue counterstain for one minute.
- Rinse slides again carefully with water, drain and air dry.

4.6.2 Fluorochrome staining method

- Prepare and heat fix smears.
- Place the numbered smears on a staining rack in batches (maximum 12).
- Flood the slides with auramine O stain and allow them to stain for 15 minutes.
- Be sure that the stain stays on the smear. Do not heat and do not use paper strips.
- Rinse the slide with water. Aim the flow of water at the edge of the slide and slowly peel the stain from the slide.
- Flood the slides with 0.5% acid alcohol and allow them to decolourise for three minutes.
- Ensure that the slides are flooded thoroughly with acid alcohol.
- Rinse off the 0.5% acid alcohol with water, drain the excess water from the slide.
- Flood each slide with potassium permanganate and allow it to quench for two minutes.
- Note: It is critical that the potassium permanganate remains on the slides for no longer than two minutes as over-quenching of fluorescence can occur.
- Wash off the potassium permanganate. Drain the excess water from the slide.
- Allow smears to air dry. Do not blot. Read as soon as possible after staining.

4.6.3 Automatic staining

Automated stainers that can process a large number of samples are commercially available. The machines require dedicated reagents and are able to perform both ZN and fluorochrome staining. Accurate and appropriate maintenance after each staining session is required to maintain consistent, high-quality staining.

4.7 Microscopy

Figure 3 shows the requirements of a microscope for smear examination.

Figure 3. Microscope components

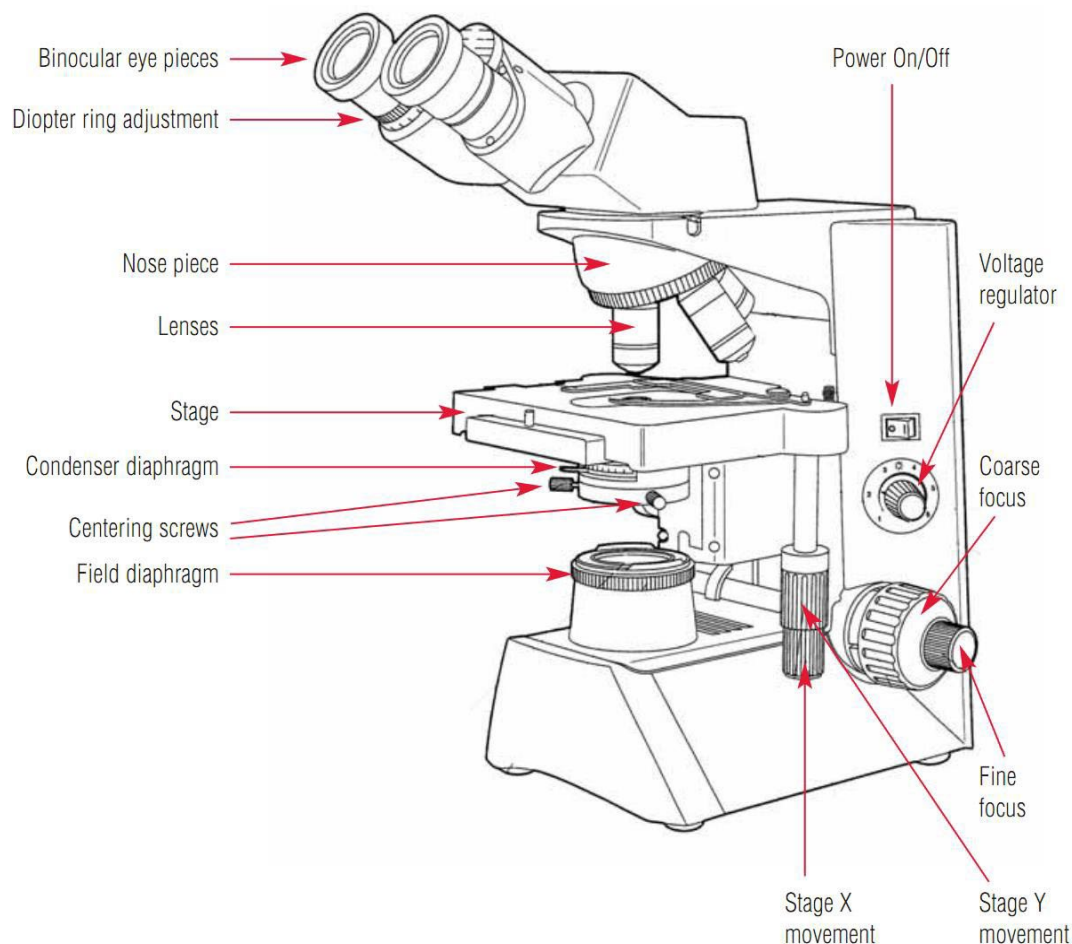

Source: Lumb R, Bastian I. Laboratory diagnosis of tuberculosis by sputum microscopy. Adelaide: Institute of Medical and Veterinary Science; 2005. p. 38. [17]

4.7.1 Maintenance

Install the microscope on a rigid, flat, level surface, away from direct sunlight, dust, vibration (e.g. from centrifuges), water (sink, spray from a tap), chemical reagents or humidity.

The modern light microscope needs no particular daily maintenance, but considerable care is required in its use. For further information, please refer to the microscope manual for care and maintenance information.

4.7.2 Fluorescence microscopy

The identification of mycobacteria with the fluorescent dye auramine O is based on the affinity of the fluorochrome to the mycolic acids in the cell wall. Auramine O is excited by blue light and emits in the region of ~500 nm to ~650 nm.

Fluorescence microscopy has some significant advantages:

- High contrast fluorescence images allow for easier detection of AFB.
- The use of low- to medium-power lenses (typically 10x, 20x and 40x) permits a larger field of view than conventional microscopy, where typically a 100x lens is used.
- The fluorochrome staining method is simpler than the ZN method.

A binocular microscope equipped with a fluorescent light source and suitable filter set is used for auramine-stained smears. Fluorescent light is provided by a vapour lamp (such as mercury or xenon lamps). The mercury vapour lamp provides the strongest light, but it has a limited lifespan of about 100 to 200 hours, which must be monitored with a timer. Moreover, these lamps are very expensive and fragile.

4.7.3 Light-emitting diode (LED) microscopy

There is a compelling base of evidence promoting ultra-bright LED microscopy as a substitute for both conventional fluorescence microscopy and direct ZN microscopy [11]. LED-based microscopy facilitates identification of acid-fast bacilli in comparison with ZN, can be used with auramine staining, is cost-effective (lifespan of the lamp is over 10 000 hours), has low power requirements, and can be easily introduced in microscopy centres, including peripheral facilities. In addition, light intensity can easily be regulated.

Since LED-based microscopy has been acknowledged as a significant development in direct fluorescence microscopy, WHO has recommended that it replace conventional fluorescence microscopy and that it be phased in as an alternative to conventional ZN microscopy in both high- and low volume laboratories. During the implementation of LED microscopy, the following issues are of importance: training requirements, validation during the introductory phase, monitoring of trends in case detection and treatment outcomes. Adapted systems may need to be introduced for internal quality control as well as external quality assurance.

4.8 Recording and reporting

Recording and reporting of results [2,6,7] is summarised in Table 9.

Table 9. Reporting of microscopy smears

IUATLD/WHO scale (1000x field = HPF)	Microscopy system		
	Bright field (1 000x magnification: 1 length = 2 cm = 100 HPF)	Fluorescence (200–250x magnification: 1 length = 30 fields = 300 HPF)	Fluorescence (400x magnification: 1 length = 40 fields = 200 HPF)
Result			
Negative	Zero AFB/1 length	Zero AFB/1 length	Zero AFB/1 length
Scanty	1–9 AFB/1 length or 100 HPF	1–29 AFB/1 length	1–19 AFB/1 length
1+	9 AFB/1 length or 100 HPF	30–299 AFB/1 length	20–199 AFB/1 length
2+	AFB/1 HPF in at least 50 fields	10–100 AFB/1 field on average	5–50 AFB/1 field on average
3+	AFB/1 HPF in at least 20 fields	>100 AFB/1 field on average	>50 AFB/1 field on average

4.8.1 ZN smear examination

Examine one length of the smear (2 cm) or 100 fields with light microscope, using 1 000x magnification. If less than 10 AFB are found in 100 fields, the number of AFB should be counted. For high positives, examination of only 20 to 30 fields is sufficient.

4.8.2 Auramine (fluorochrome) smear examination

Examine one length of an auramine slide with a fluorescent microscope, using 200–250x magnification, to cover 30 fields in one length, equivalent to 300 fields at 1 000x magnification. Alternatively, 400x magnification can be used, covering 40 fields at this magnification.

Negative report: Negative for acid-fast bacilli where no organisms observed in 100 fields. Positive report: Positive for acid-fast bacilli; provide AFB quantification.

The results should be recorded in the TB laboratory register, and recorded on the sample examination request form as well as forwarded to the person requesting the sample examination [10].

Figures 4–5 give examples of smear microscopy using auramine and ZN staining.

Figure 4. AFB smear microscopy of biological specimens

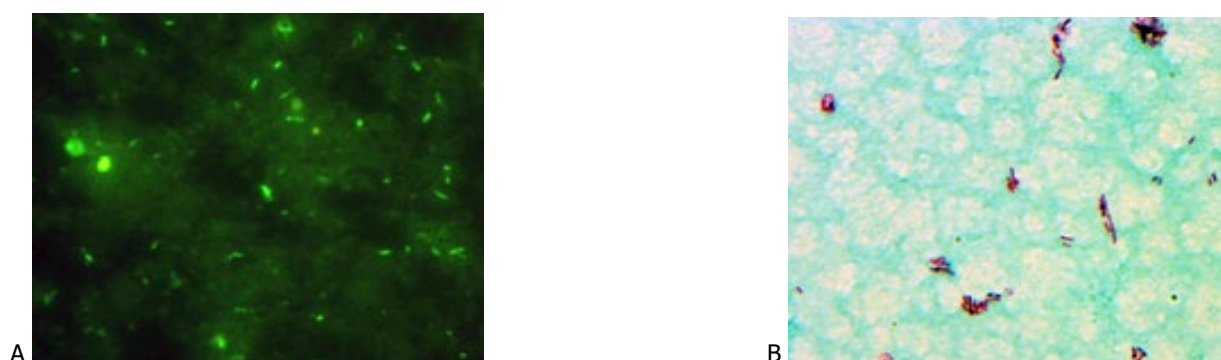
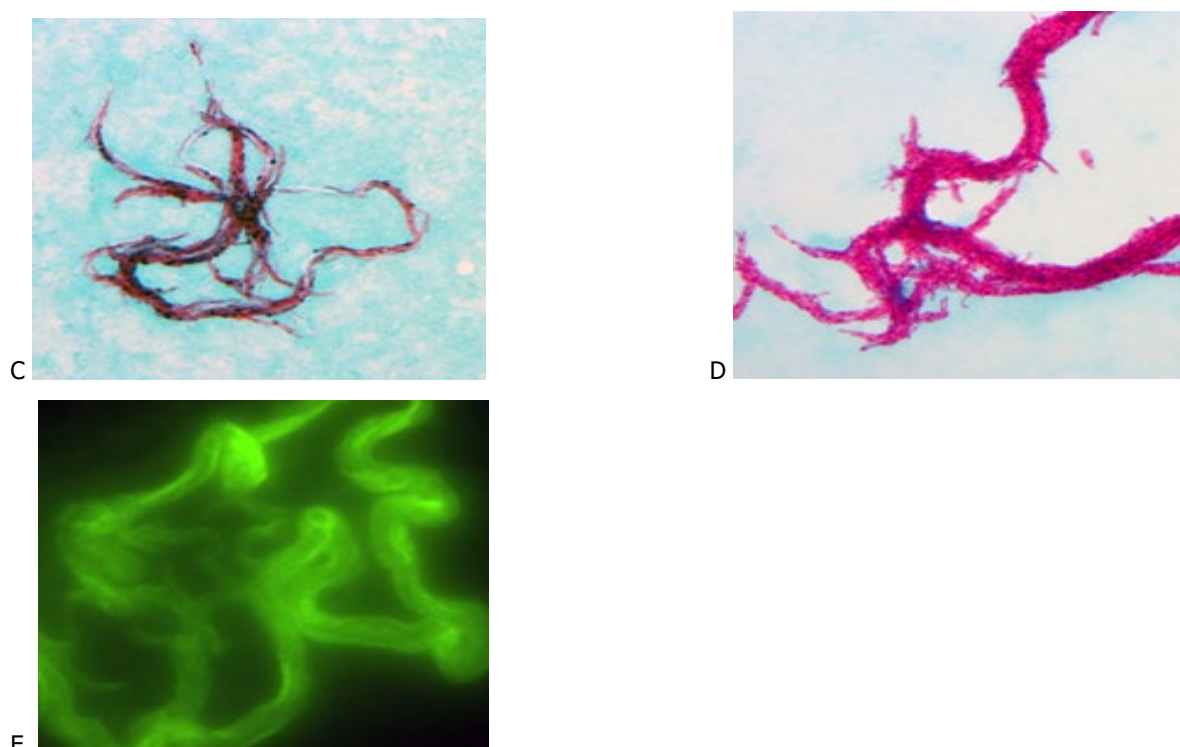

Figure 5. AFB smear microscopy of *M. tuberculosis* cultures



A and E: Auramine stain B–D: Ziehl-Neelsen stain

Images show cords. Pictures were kindly provided by Professor Zofia Zwolska, Head of the Microbiology Department, National Tuberculosis Reference Laboratory, National Tuberculosis and Lung Diseases Research Institute, Warsaw, Poland.

4.9 Quality control

4.9.1 Quality control parameters

Quality control in microscopy is a process for internally monitoring the performance of bench work in the laboratory. It consists of an effective and systematic process, ensuring that laboratory work is accurate, reliable and reproducible. This is done by assessing the quality of specimens; monitoring the performance of microscopy procedures, reagents and equipment; reviewing microscopy results and documenting the validity of microscopy methods.

A positive and a negative control slide should be included in each run of stains, verifying the correct performance of the procedure as well as the staining intensity of the acid-fast organisms [14,15].

Table 10 shows the most common causes of error in smear microscopy. Control slides should be assessed prior to reading the patient smears to confirm the correctness of staining. If quality control slides are acceptable, patient smears can be read and reported. If the control slide(s) are unacceptable, the procedures and reagent preparations should be reviewed. After identifying and correcting the problem, all patient slides should be repeated with a new set of controls. The results of the quality control of reagents should be reported in the reagent preparation workbook.

Table 10. Common causes of error in smear microscopy

Errors	Cause	Action to be taken
False negative	Smear too thick, detaching during staining	Improve homogenisation, reduce the material deposited.
	Smear too thin	Increase the amount or make smear in 1x2 cm area only.
	Poor staining	Check quality control of reagents, prepare new reagents, check dilution.
False positive	Cross-contamination	Avoid contact between slides during staining procedure, do not use staining jars. Clean objective lens after reading each slide. Check water/solutions for environmental contamination.
	Red precipitates	Prepare new solution. Filter before use.

References

1. United States Department of Health and Human Services. Public health mycobacteriology: a guide for the level III laboratory. Atlanta, CDC; 1985.
2. World Health Organization (WHO). Laboratory services in tuberculosis control. Part II: Microscopy. Geneva: WHO; 1998. Available at: <http://www.who.int/iris/handle/10665/65942>
3. World Health Organization (WHO). Maintenance and repair of laboratory, diagnostic imaging and hospital equipment. Geneva: WHO; 1994. Available at: <http://www.who.int/iris/handle/10665/40508>
4. World Health Organization (WHO). Maintenance manual for laboratory equipment, 2nd Edition. Geneva: WHO; 2008. Available at: <http://www.who.int/iris/handle/10665/43835>
5. World Health Organization (WHO). Manual of basic techniques for a health laboratory, 2nd ed. Geneva: WHO; 2003. Available at: <http://www.who.int/iris/handle/10665/42295>
6. Rieder HL, Van Deun A, Kam KM, Kim SJ, Chonde TM, Trébuq A, et al. Priorities for tuberculosis bacteriology services in low-income countries. 2nd ed. Paris: International Union against Tuberculosis and Lung Disease; 2007.
7. United States' Centers for Disease Control (CDC). Acid-Fast Direct Smear Microscopy – A Laboratory Training Program. Atlanta, CDC; 2000. Available at: <http://stacks.cdc.gov/view/cdc/31282>
8. Health Protection Agency, Standards Unit, Evaluations and Standards Laboratory. Investigation of specimens for *Mycobacterium* species. London: Health Protection Agency; 2006. Available at: <https://www.gov.uk/government/publications/smi-b-40-investigation-of-specimens-for-mycobacterium-species>
9. Collins C, Grange J, Yates M. Organization and practice in tuberculosis bacteriology. London: Butterworths; 1985.
10. World Health Organization (WHO). Revised TB recording and reporting forms and registers – version 2006. Geneva: WHO; 2006. Available at: <http://www.who.int/iris/handle/10665/69608>
11. World Health Organization (WHO). Fluorescent light-emitting diode (LED) microscopy for diagnosis of tuberculosis policy – Policy statement. Geneva: WHO; 2010. Available at: <http://www.stoptb.org/wg/gli/assets/documents/WHO%20Policy%20Statement%20on%20LED%20Microscopy%20FINAL%20March%202010.pdf>
12. World Health Organization (WHO). A Roadmap for Ensuring Quality Tuberculosis Diagnostics Services within National Laboratory Strategic Plans. Prepared by The Global Laboratory Initiative Advancing TB Diagnosis. Geneva: WHO; 2010. Available at: http://www.who.int/tb/laboratory/gli_roadmap.pdf
13. World Health Organization (WHO). New Laboratory Diagnostic Tools for TB Control. Geneva: WHO; 2008. Available at: <http://www.who.int/tdr/publications/non-tdr-publications/diagnostic-tool-tb/en>
14. Isenberg HD. Clinical microbiology procedures handbook. Washington: ASM Press; 1992.
15. Cirillo D, Piana F, Vincent V, Angra P, Barrera L, Boulahbal F, et al. Training package on culture of acid-fast bacilli and drug-susceptibility testing of *Mycobacterium tuberculosis*. In: Tuberculosis Control Assistance Program. TB CAP Toolbox – TB CAP Laboratory Tools [CD ROM]. n.p.; 2009.
16. Vincent V, van Deun A, Feldmann K, Barrera L, Paramasivan CN, Weyer K, et al. Guidance for countries on the preparation and implementation of TB laboratory standard operating procedures (WHO SOPs). In: Tuberculosis Control Assistance Program. TB CAP Toolbox – TB CAP Laboratory Tools 2009 [CD ROM].
17. Lumb R, Bastian I. Laboratory diagnosis of tuberculosis by sputum microscopy. Adelaide: Institute of Medical and Veterinary Science; 2005. p. 38.

5 Culture tests for *Mycobacterium tuberculosis* complex

Susana David, Vera Katalinić-Janković, Lanfranco Fattorini and Daniela Cirillo

Revised by Emanuele Borroni, Enrico Tortoli, and Vladyslav Nikolayevskyy (2015)

5.1 Background and principles

Bacteriological cultures can provide a definitive diagnosis of TB. The primary advantage of culture tests over sputum microscopy is their higher sensitivity, allowing for the detection of very low numbers of bacilli (approximately 10 bacilli/ml of sputum compared with at least 5 000 bacilli/ml of sputum for microscopy). The use of cultures increases the potential of diagnosing TB at early stages of the disease. Culture tests are also used for the detection of treatment failures and for diagnosing extrapulmonary TB. The use of culture tests increases the number of TB cases found by 30–50%. Moreover, cultures are used for species identification and drug susceptibility testing (DST) [1,2].

As the EU has adopted the culture-based case definition, the main distinction in TB cases is between culture-positive and -negative, and not sputum smear status. The first section of the European Standards for Tuberculosis Care (ESTC) 2012 [1] dedicated to the Standards for Diagnosis (ESTC 1 through ESTC 6) specifies the minimum requirements for obtaining a valid TB diagnosis in different settings or with various suspect types, both microbiological and clinical [1,2]. If this is not feasible, culture tests should at least be performed for:

- diagnosis of cases with clinical and radiological signs of pulmonary TB where smears are repeatedly negative;
- diagnosis of extrapulmonary TB;
- diagnosis of childhood TB;
- diagnosis of TB among HIV-positive adults and children; and
- diagnosis and monitoring of MDR- and XDR-TB.

TB, although mainly a pulmonary disease, can affect any organ of the body. The isolation of the aetiological agent for effective microbiological diagnosis is dependent on:

- selection of the correct type of specimen;
- the quality of the sample; and
- adequate use of storage and transportation procedures.

Processing of inappropriate clinical specimens for mycobacterial cultures is a waste of both financial and human resources [6]. Clinical staff should be properly trained and accept only suitable specimens.

Because mycobacteria are usually slow growing and require a long incubation time, a variety of other microorganisms can overgrow the cultures of specimens obtained from non-sterile sites. Appropriate pre-treatment and processing of samples, as well as the use of selective culture media is critical for eliminating contaminants while not seriously affecting the viability of mycobacteria [10].

5.2 Biohazards and biosafety in the TB laboratory

Good microbiological techniques (GMT) – working methods designed to eliminate or minimise exposure to pathogens via, for example aerosols, splashes or accidental inoculation – are essential for minimising biohazards [13]. Nosocomial transmission of *M. tuberculosis* from specimens is a major concern for laboratory workers. All specimens suspected of containing *M. tuberculosis* should be handled with appropriate precaution at all times and opened only within an appropriate biosafety cabinet. Infectious aerosols are produced in the TB laboratory whenever a liquid suspension containing tubercle bacilli is handled. Biosafety measures in the laboratory are essential to protect workers against exposure to infectious aerosols. Please refer to Chapter 1 for more details on procedures and laboratory safety practices.

Because of their viscosity, sputa are a minimal source of infectious aerosols. By contrast, aerosols produced during processing (especially during centrifugation) of homogenised sputa and during culture handling, must be minimised and therefore processed and contained in a biological safety cabinet.

Classification of laboratory practices used for *M. tuberculosis* diagnosis should be based on a risk assessment (number and type of tests, prevalence of tuberculosis and of MDR-TB). Specimen processing for mycobacterial culture should be performed in a biological safety cabinet in at least a biosafety level 2 (BSL2) laboratory, whereas procedures involving manipulation of *M. tuberculosis* cultures (identification, sub-culturing, and DST) must be

performed in a biological safety cabinet in laboratories complying with BSL3 standards. All aerosol-generating procedures should be performed in a class I or II biological safety cabinet [9-11].

The health of laboratory workers should be regularly monitored by the employer. They should be educated about the symptoms of TB and, if symptoms arise, they should be provided with readily accessible free medical care in accordance to the national regulations.

5.2.1 Minimum WHO recommendations for TB culture/drug susceptibility testing facilities

WHO recommends that all specimen processing procedures are carried out in a laboratory built and equipped for BSL2. The minimum requirements for a BSL2 TB laboratory are: restricted access to the laboratory, the presence of a fully functional and maintained biological safety cabinet and an autoclave or other means of decontamination available in the same building. More information on biosafety is given in Chapter 1 [9-14].

Identification, subculturing, and drug susceptibility testing should be performed in a BSL3 containment room with an anteroom and directional airflow from functionally clean to dirty areas, with at least six to 12 air exchanges per hour. The containment room may be the blind end of a corridor or formed by constructing a partition and door so that access to the laboratory is through an anteroom (e.g. double-door entry) or through the basic BSL2 laboratory. The autoclave should be in the vicinity of the laboratory so that the movement of contaminated materials is minimised. Biological safety cabinets must be ducted to the outside or vented through a thimble. Recirculation of air from biological safety cabinets into the laboratory room and recirculation to other areas within the building are not permitted. Please refer to Chapter 1 for further detail on laboratory safety levels and conditions [14].

The decision to use additional PPE should be based on risk assessments. Risk assessments should be reviewed routinely and revised when necessary [7].

Masks and respirators

One of the most common misconceptions is that a standard surgical mask can provide protection against *M. tuberculosis* infectious aerosols. Surgical masks made from poorly fitting porous material leave large gaps between the face and mask and therefore only help to prevent the spread of microorganisms from the wearer to others by capturing the large wet particles in the exhaled air.

Although biological safety cabinets and airflow in the laboratory are the main means of protection against exposure to contaminated aerosols generated during culture and drug susceptibility testing activities, the need for additional personal protection must be considered in certain settings, such as when MDR-TB and/or HIV are prevalent. Staff may be HIV-infected and highly susceptible to contaminated aerosols [14].

Protection from inhalation of infectious aerosols can be provided by respirators, which are devices with the capacity to filter particles of 0.3–0.4 µm diameter and fit closely to the face to prevent leakage around the edges. The N95 (FFP2) respirator is a lightweight, disposable nose and mouth respirator; it effectively filters out more than 95% of particles of diameter 0.3 µm and above. The FFP3 respirator removes more than 98% of such particles. Each user should be instructed in the proper use of the respirator and informed about its limitations. Respirators should be correctly fitted to the face to prevent leakage from around the face seal. This is done by placing the mask over the nose and mouth with the top elastic band over the crown of the head and the bottom elastic band over the back of the neck. The metal strip covering the nose should be firmly moulded over the bridge of the nose. Facial hair between the wearer's skin and the sealing surfaces of the respirator will prevent a good seal. Respirators should also be worn during emergency cleaning of spillages involving the release of viable organisms into the work area. Respirators should be stored in a convenient, clean, and sanitary location and discarded after eight hours of (cumulative) use and not be kept for more than one week [7].

Gloves

In accordance with international, universal procedures/guidelines, appropriate gloves should be worn for all procedures that involve the handling of body fluids. Gloves must be worn in case of hand injury/skin disease or when the risk of exposure to blood-borne pathogens is high; consequently, specimens resulting from invasive clinical investigation must be handled with gloves [12,14].

Gloves must be changed after every session that requires their use and after every interruption of the activity. Never wear gloves outside the laboratory. Every time hands are removed from the biological safety cabinet, gloves must be pulled off and discarded in a waste container in the safety cabinet [7,12,14].

Disposable latex, latex-free vinyl (clear) or nitrile gloves can be used and the correct size (small, medium, or large) should be available for all individuals. Hypoallergenic gloves should be provided in case of allergy to latex proteins and/or to the corn-starch used for powder. Re-using single-use gloves is not advised. Used gloves should be discarded as contaminated material. Following the safe removal of gloves, wash hands immediately with water and

liquid soap. Proper hand-washing with soap and adequate care in the handling of contaminated materials are critical elements of safe laboratory practice [14].

Gowns

Always wear a gown inside the laboratory (never outside) and change at least weekly. Long-sleeved back-opening gowns or overalls with narrow cuffs give better protection than laboratory coats and are preferred in microbiology laboratories. When worn, laboratory coats should be fully buttoned. An area of the laboratory must be designated for storage of used and new clothing. Laboratory gowns must be stored away from personnel clothing. Laundering services should be provided at/near the facility. Extra clothing should be available suitable for visitors, maintenance and emergency response personnel [7,12,14].

Always remove personal protective equipment in the following order:

- disposable gloves;
- gown/coat/suit/overalls; and
- respirator/mask.

5.3 Specimen collection, storage and transport

5.3.1 Sample collection

Proper specimen collection procedures and containers, adequate specimen volumes and appropriate transport conditions can all affect TB culture results. Correct labelling of specimens is critical. This includes patient and sample identification, sample type and date of collection.

As a general rule, it is preferable that specimens are collected before starting specific treatments. Specimens should always be collected with care to avoid contamination by host or environmental microorganisms and submitted in sterile, leak-proof, disposable, appropriately labelled, laboratory-approved containers without any fixatives.

If centrifugation is used for culture tests, the use of collection containers suitable for centrifugation should be considered. Decontamination and centrifugation in the collection container avoids having to transfer samples to another container [1-8].

Sputum samples

Most specimens received by the laboratory are sputum samples. Patients should be clearly instructed on how to collect the sputum specimen; written instructions must be provided.

A systematic review of 37 eligible studies [6] clearly showed that most TB cases (average 85.8%) were detected with the first sputum specimen. With the second sputum specimen, the average incremental yield was 11.9%; with the third specimen (when the first two were negative) the incremental yield was 3.1%. It is expected that laboratory analysis of two sputum smear samples will improve case-finding, reduce time to diagnosis, accelerate initiation of treatment and decrease the number of patients lost during the diagnostic process. Based on this evidence, WHO has recommended that two sputum samples in a single day be used to diagnose pulmonary TB in settings where a well-functioning EQA system is in place, the workload is high and human resources are limited.

A good sputum specimen should be approximately 3–5 ml of recently-discharged material from the bronchial tree. It is usually thick and mucoid. It may be fluid and contain pieces of purulent material. The colour may vary from opaque white to green. Bloody specimens will appear reddish or brown. Clear saliva or nasal discharge is not suitable as a TB specimen, although saliva should not automatically be rejected: induced and follow-up sputa resemble saliva. To avoid contamination or dilution of a good sample, specimens should not be pooled.

Other specimens

Body fluids (spinal, pleural, pericardial, synovial, ascitic, blood, pus, and bone marrow) should be aseptically collected in sterile containers using aspiration techniques or surgical procedures. Pleural effusion is a suboptimal specimen: tubercle bacilli are mainly in the pleural wall and not in the fluid. The minimum volume for pleural effusion is 20–50 ml. A pleural biopsy specimen is ideal.

For fluids that may clot, sterile potassium oxalate (0.01–0.02 ml of 10% neutral oxalate per ml fluid), heparin (0.2 mg/ml), or sodium citrate (two drops of 20% sodium citrate for every 10 ml of fluid) should be added as an anticoagulant to the culture.

Aseptically collected tissues should be placed in sterile containers without fixatives or preservatives and transported quickly to the laboratory. For prolonged transportation, dehydration should be prevented by adding sterile saline and maintaining a temperature of 4–15°C.

Urine is expected to be contaminated. To minimise excessive contamination of urine specimens, external genitalia should be washed before specimen collection. Once received in the laboratory, a urine sample must either be

processed immediately or centrifuged and the pellet refrigerated. As excretion of tubercle bacilli is intermittent, three consecutive early-morning midstream specimens must be collected.

Other respiratory specimens that can be submitted to the laboratory for mycobacterial culture are bronchial secretion (minimum volume 2–5 ml) and bronchial alveolar lavage samples (minimum volume 20–50 ml). Transbronchial and other biopsies taken under sterile conditions should be kept wet during transportation by adding 0.5–1 ml sterile 0.9% saline.

In children who produce little, if any sputum, aspiration of the early-morning gastric juice can be used for TB diagnosis. The gastric aspirate should be transported immediately to the laboratory and neutralised by adding 100 mg of sodium bicarbonate.

5.3.2 Storage of specimens

Specimens should be correctly collected and delivered as quickly as possible to the laboratory. Every effort must be made to organise and expedite specimen transportation and processing. Although TB bacilli can survive in sputum for one week in the absence of preservatives, the probability of successfully culturing the bacilli decreases with time and this is especially critical for paucibacillary specimens. If specimens cannot be transported to the laboratory within one hour, it is recommended to store them at 4°C. This does not apply to whole blood specimens, which are not to be refrigerated. On arrival at the laboratory, specimens should again be refrigerated until they can be processed. The delay between collection and inoculation should not exceed seven days.

5.3.3 Transportation of specimens

Packaging of infected specimens that are to be sent by surface or air mail must be carried out according to national biosafety and biosecurity guidelines or international rules. For international transfer of infectious substances, the International Air Transport Association (IATA) should be contacted [7].

Specimens and cultures should be packaged in a three-component packaging consisting of:

- a leak-proof primary receptacle(s);
- a leak-proof secondary packaging; and
- an outer packaging of adequate strength for its capacity, mass and intended use.

For the purposes of transport, infectious substances are defined as substances which are known or reasonably expected to contain pathogens [7,8]. Category A (UN2814) corresponds to an infectious substance which is transported in a form that, when exposure to it occurs, is capable of causing permanent disability, and/or life-threatening or fatal disease in otherwise healthy humans or animals. All other infectious substances as well as human biological specimens belong to Category B (UN3373).

Cultures of *M. tuberculosis* belong to Category A. However, for surface transport, when *M. tuberculosis* cultures are intended for diagnostic or clinical purposes, they may be classified as category B. For surface transport there is no maximum quantity per package.

For air transport:

- no primary receptacle should exceed 1 l (for liquids) or the outer packaging mass limit (for solids); and
- the volume shipped per package should not exceed 4 l or 4 kg.

These quantities exclude ice, dry ice or liquid nitrogen when used to keep specimens cold.

5.4 Homogenisation and decontamination of specimens

Most (but not all) specimens are considered contaminated. Pulmonary specimens including sputum, bronchial secretions, bronchoalveolar lavage, bronchial aspirates and brushings are usually contaminated by normal host microbiota. Extrapulmonary specimens may be divided into two main groups according to the extent of contamination:

- Aseptically collected specimens, usually free from other microorganisms (sterile);
- Specimens contaminated by normal flora or specimens not collected aseptically (not sterile).

Normally, contaminated extrapulmonary specimens are gastric lavage, laryngeal aspirates, urine, skin, autopsy materials, and uterine mucosa. Sterile specimens include pus from cold abscess, CSF, synovial or other cavity body fluids, as well as surgical biopsies.

Contaminated specimens must be subjected to rigorous decontamination procedures that liquefy the organic debris and eliminate the unwanted normal flora. Normal flora would rapidly overgrow the entire surface of the medium and consume it before the TB bacilli started to grow. Specimens must be homogenised to free the bacilli from the mucus, cells or tissue in which they may be embedded.

Digesting/decontaminating agents are to some extent toxic to tubercle bacilli and therefore to minimise the number of dead mycobacteria, the digestion/decontamination procedure must be followed precisely. A proportion of cultures will be contaminated by other organisms: a contamination rate of 3–5% is acceptable on solid media. Cultures in liquid media may show higher contamination rates (5–10%). Furthermore, if specimens (especially

sputum) take several days to reach the laboratory, the contamination rate may be higher. At present, new commercial kits are available, containing transportation media supplemented with decontamination solutions for longer shipments between countries or cities. These may help to reduce the proportion of contaminated cultures due to long shipments and increase the proportion of positive cultures among those samples which are not inoculated at the point of collection. A contamination rate that approaches 0 indicates that the decontamination procedure was too harsh.

5.4.1 Digestion and decontamination of sputum samples

Digestion and decontamination using the sodium hydroxide (modified Petroff) method

Sodium hydroxide is toxic, both for contaminants and for tubercle bacilli; strict adherence to the indicated timings is therefore essential. This decontamination procedure can only be used for samples which will then be inoculated on solid media.

Reagents:

- Sodium hydroxide (NaOH) solution, 4%;
- Phosphate buffer 0.067 mol/l, pH 6.8.

Sodium hydroxide (NaOH) solution, 4%:

- Sodium hydroxide pellets (analytical grade): 4 g;
- Distilled water: 100 ml.

Dissolve NaOH in the distilled water. Aliquot in 2 ml quantities. Sterilise by autoclaving at 121°C for 20 minutes.

Phosphate buffer, 0.067 mol/l, pH 6.8:

- Stock solution A: disodium phosphate, 0.067 mol/l.

Dissolve 9.47 g of anhydrous Na₂HPO₄ in 1 l of distilled water.

- Stock solution B: monopotassium phosphate, 0.067 mol/l.

Dissolve 9.07 g of KH₂PO₄ in 1 l of distilled water.

Mix 50 ml of solution A and 50 ml of solution B. Use a pH meter to confirm that the correct pH for the buffer is reached. Adjust as necessary, using 10% phosphoric acid or 10% sodium hydroxide.

Aliquot in the volumes required for adding to a single centrifugation tube (e.g. 50 ml amounts if 50 ml centrifuge tubes are used), discarding the extra volume. Sterilise by autoclaving at 121°C for 20 minutes. Leftover volumes of buffer can then be pooled and sterilised again for further use.

Procedure:

- If sputum has not already been collected in centrifuge tubes, select sterile plastic screw-top centrifuge tubes (one for each specimen).
- With a permanent marker, write the number of the specimen on the wall of the tube (not on the cap).
- Write the number of each specimen and the inoculation date on two tubes of media.
- Mark the volume of sputum on the centrifuge tube (at least 2 ml, not more than 5 ml). Add an equal volume of 4% NaOH and tighten the screw-cap.
- Vortex to digest.
- Allow to stand for 15 minutes at room temperature.
- Fill the tube to within 2 cm of the top (e.g. to the 50 ml mark on the tube) with phosphate buffer.
- Centrifuge at 3 000 g for 15 minutes.
- Carefully pour off the supernatant through a funnel into a discard can containing 5% phenol or another mycobacterial disinfectant.
- Re-suspend the deposit in approximately 0.3 ml phosphate buffer.
- Inoculate the deposit on two slopes of egg-based medium labelled with the ID number. Use a pipette to inoculate each slope with 3–4 drops (approximately 0.1–0.15 ml).
- Smear one drop on a slide, marked with the ID number, for microscopic examination.

Digestion and decontamination using the N-acetyl-L-cysteine-sodium hydroxide (NALC-NaOH) method

The most widely used method for the digestion and decontamination of contaminated specimens is the N-acetyl-L-cysteine-sodium hydroxide (NALC-NaOH) method.

Decontamination using NALC-NaOH is based on the mucolytic properties of N-acetyl-L-cysteine (NALC) which enable the decontaminating agent, sodium hydroxide, to be used effectively at a low, final concentration.

Consequently, the NALC method results in more positive cultures than other methods, as it only kills about 30% of the tubercle bacilli in clinical specimens; a lower NaOH concentration means that contamination rates may be higher than for other decontamination methods. The time needed to process a single specimen is approximately 40 minutes, while 20 specimens would take approximately 60 minutes.

This method is suitable for cultures on both solid and liquid media. However, the disadvantages of the method are that NALC loses activity and must therefore be made fresh every day. Commercially prepared solutions are available, but expensive.

After exposure to the decontaminant and subsequent centrifugation, it is essential that the sediment is re-suspended in a 1:10 dilution of buffer (or water) to reduce the concentration of any toxic components that may inhibit the growth of TB bacilli.

As a measure of precaution, an aliquot of the sediments should be kept for one week in the refrigerator and re-decontaminated if the inoculated cultures show signs of contamination. Optionally the sediment can be frozen (- 20°C) in a screw-cap sterile 1.5-2 ml vial that is properly labelled.

Reagents N-acetyl-L-cysteine-sodium hydroxide (NALC-NaOH) method:

Sodium hydroxide-citrate solution

Solution A: Sodium hydroxide 4%	
Sodium hydroxide pellets (analytical grade)	40 g
Distilled water	1 000 ml

Dissolve NaOH in the distilled water

Solution B: Trisodium citrate 3H₂O 2.94%	
Trisodium citrate 3H ₂ O	29.4 g
Distilled water	1 000 ml

Dissolve trisodium citrate 3H₂O in the distilled water.

Mix solutions A and B, aliquot in 100 ml quantities, and sterilise by autoclaving at 121°C for 15 minutes. Store at 4°C in refrigerator.

N-acetyl-L-cysteine (NALC)

NALC-NaOH solution should be freshly prepared for daily use only.

Prepare by adding 0.5g NALC to 100 ml of the sodium hydroxide-citrate solution just before use: aliquot in 4 ml amounts.

Phosphate buffer, 0.067 mol/l, pH 6.8

See above for preparation.

Sputum processing

Sputum specimens are not to be pooled because of the risk of cross-contamination. Always digest/decontaminate the whole specimen – do not attempt to select portions of the specimen as is done for direct microscopy. Gently decant from the specimen container into the centrifuge tube. If the specimen is too viscous to pour, an equal volume of digestant/decontaminant can be added to the sputum in the specimen container before the mixture is poured carefully into an appropriate screw-top centrifuge tube.

Sputa are not to be processed in batches of more than 6–8 as the method is strictly time-dependent. Procedure:

- If sputum has not already been collected in centrifuge tubes, select sterile plastic screw-top centrifuge tubes (one for each specimen).
- With a permanent marker, write the number of the specimen on the wall of the tube (not the cap).
- Write the number of each specimen and the inoculation date on two tubes of media.

- Transfer the sputum (at least 2 ml, but no more than 5 ml) into a centrifuge tube. Add an equal volume of NALC-NaOH solution.
- Tighten the cap of the tube and shake or vortex. Mix for no more than 20 seconds.
- Keep at 20–25°C for 15 minutes to decontaminate.
- Fill the tube to within 2 cm of the top (e.g. the 50 ml mark on the tube) with 0.067 mol/l phosphate buffer (pH 6.8) or distilled water. Vortex mix.
- Centrifuge at 3 000g for 15 minutes.
- Carefully pour off the supernatant into a discard bottle containing the appropriate disinfectant.
- Re-suspend the deposit and inoculate onto two slopes of LJ medium (and one slope of LJ with pyruvate if needed) or into liquid medium. Using a pipette (not a loop), inoculate each slope with 3–4 drops (0.2–0.4 ml). Smear one drop on a slide (marked with the ID number) for microscopic examination.

5.4.2 Digestion and decontamination of specimens other than sputum

Laryngeal swabs

Smear examination is not done for laryngeal swabs. Swabs yield little material: as much of the material as possible must be collected and not wasted.

- Swabs must be cultured on the day they are received using sterile precautions.
- Use sterile forceps to transfer the swab to a sterile centrifuge tube.
- Add 2 ml of sterile distilled water.
- Decontaminate according to NaOH-NALC method (see above, Section 5.4.1).
- Before adding the phosphate buffer solution, remove the swab from the tube using sterile forceps.
- Fill the tube to within 2 cm of the top (e.g. the 50 ml mark on the tube) with phosphate buffer, 0.067 mol/l, pH 6.8 and mix the contents by inversion.
- Centrifuge at 3 000g for 15 minutes.
- Carefully pour off the supernatant into a discard bottle containing an appropriate disinfectant.
- Inoculate the deposit on two slopes of LJ medium (and one slope of LJ with pyruvate, if needed) or in liquid medium. Using a pipette (not a loop), inoculate each slope with 3–4 drops.

Gastric lavages

Gastric lavage specimens should be processed as soon as possible after collection; acidity can kill mycobacteria in the specimen so gastric lavage specimens must be processed within four hours. The gastric aspirate should be collected in a tube containing 100 mg of sodium bicarbonate for neutralisation and should be transported immediately to the laboratory. Proceed as for sputum.

If the specimen is watery, centrifuge at 3 000g for 15 minutes, pour off the supernatant, re-suspend the sediment in 5 ml of sterile distilled water and proceed as for sputum.

Mucopurulent materials

Handle as for sputum when the volume is 10 ml or less.

Handle as for mucoid gastric lavage when the volume is more than 10 ml.

Fluid materials

If the specimen has been collected aseptically, centrifuge and inoculate the sediment directly onto culture media, preferably liquid medium.

Materials that should not be decontaminated are:

- spinal, synovial or other cavitory body fluids;
- bone marrow;
- pus from cold abscesses;
- surgically resected specimens (excluding autopsy material); and
- material obtained from pleural, liver and lymph nodes as well as biopsies (if not fistulised).

To maximise the recovery rate, the entire CSF volume (or other small volume of aseptically collected fluid) should be cultured, preferably in liquid medium.

If the specimen was not aseptically collected:

- Handle as for sputum when the volume is 10 ml or less;
- Handle as for fluid gastric lavage when the volume exceeds 10 ml.

Tissue

If a biopsy needs to be processed for smear and culture, it is necessary to homogenise the biopsy in a sterile porcelain mortar or preferably in a small, non-reusable tissue grinder with 2–5 ml of sterile saline.

Mortars, pestles, and tissue grinders must be cleaned and sterilised thoroughly to prevent false-positive results or contamination due to organisms left over from previous specimens. Lymph nodes, biopsies and other surgically resected tissue should be cut into small pieces with a sterile scalpel or scissors. Homogenise the specimen in a sterile porcelain mortar or tissue grinder using 5 ml sterile saline and a small quantity of sterilised sand. Inoculate the suspension onto culture media.

5.5. Culture media: principles

As *M. tuberculosis* grows slowly, with a generation time of 18–24 hours (other bacteria reproduce within minutes), usual bacteriology techniques are not applicable to mycobacterial cultures. Moreover, growth requirements are such that *M. tuberculosis* will not grow in primary isolation on simple, chemically-defined media. The only media that allows for abundant growth are egg-enriched media containing glycerol and asparagine, and agar or liquid media supplemented with serum or bovine albumin. Many different media have been developed for *M. tuberculosis* growth and are generally classified into two main groups: solid media (egg- and agar-based) and liquid media.

Antibiotics can be added to culture media in order to prevent the growth of non-specific flora.

Both solid and liquid media are recommended for *M. tuberculosis* isolation from biological samples. An advantage of solid over liquid media is that colonies of mixed cultures and contaminants can be observed while liquid media promotes a faster growth of mycobacteria.

The choice of media depends primarily on the type of specimen. Non-selective media are recommended for use with samples from normally sterile sites (bone marrow, tissue biopsy samples, cerebrospinal fluid and other body fluids etc.), while selective media, that contain antimicrobial agents to prevent growth by contaminating bacteria and fungi, are recommended for use with contaminated (or potentially contaminated) specimens (sputum, abscess contents, bronchial washings, gastric lavage fluid, urine, etc.) [1,2].

The most commonly used non-selective media are:

- egg-based media: Löwenstein-Jensen (LJ) medium and Ogawa medium
- agar-based media: Middlebrook 7H10 and Middlebrook 7H11; and
- liquid media: Middlebrook 7H9 broth.

Other commonly used selective media available in some countries are:

- Egg-based media: Gruft modification of LJ (containing malachite green, penicillin and nalidixic acid as selective agents, and Mycobactosel LJ (containing malachite green, cycloheximide, lincomycin and nalidixic acid as selective agents);
- Agar-based media: selective 7H11 (Mitchison's medium), containing carbenicillin, amphotericin B, polymixin B and trimethoprim as selective agents; and
- Liquid media: in general they contain a modified Middlebrook 7H9 broth plus a mixture of antimicrobial agents. Several automated systems have been commercially developed for rapid detection of mycobacteria in liquid medium:
 - BACTEC µGIT 960 system (BD [Becton, Dickinson and Company] Diagnostic Systems);
 - ESP Culture System II (Trek Diagnostic Systems);
 - MB/BacT (bioMérieux).

5.6 Solid media

5.6.1 Egg-based media

LJ medium, which contains malachite green as an inhibitor of non-mycobacterial organism, is the most commonly used egg-based medium, especially for sputum culture. LJ is user-prepared or commercially prepared in slant tubes. LJ containing glycerol favours *M. tuberculosis* growth, while LJ without glycerol but containing sodium pyruvate enhances *M. bovis* growth. Both media should be used in geographical regions where patients may be infected with either organisms [3]. Ogawa medium is LJ without asparagine. Non-selective egg-based media can be stored in the refrigerator for several months provided that the tube caps are tightly closed to minimise evaporation.

A disadvantage of egg-based media is that when contamination does occur it may involve the entire slant surface, so the culture is generally lost. If specimens contain few bacilli it may take three to eight weeks before cultures become positive.

5.6.2 Agar-based media

These media are prepared in slant tubes or plates and are less likely than egg-based media to become contaminated. Middlebrook 7H10 and 7H11 media are usually prepared in the laboratory from commercially available agar-powdered bases, with the addition of Middlebrook oleic acid-albumin-dextrose-catalase (OADC) enrichment. Because of the transparency of 7H10 and 7H11 plates, *M. tuberculosis* micro colonies with typical cord formation can be detected and counted using a microscope as early as one week after incubation. Moreover, visibility of colonial morphology on agar plates is better than on egg-containing slants, aiding the identification of mycobacteria. Middlebrook 7H11 is preferable to 7H10 because it contains 0.1% casein hydrolysate, a substance favouring the recovery of isoniazid-resistant mycobacteria. Furthermore, 7H11 is also better for growing multi-drug-resistant (MDR) strains as these may not grow at all on 7H10 agar plates.

A disadvantage of Middlebrook media is that the surface dries more rapidly than egg-based media. It is important to know that daylight, heating, and storage at 4°C for more than four weeks may cause the release of formaldehyde in a sufficient concentration to inhibit the growth of mycobacteria.

5.6.3 Liquid media

Liquid media offer a considerable time advantage over solid media: 7–14 days in Middlebrook 7H9 liquid medium, compared with 18–28 days in Middlebrook 7H11 agar, or 21–42 days in LJ medium [5].

One of the most widely used automated systems for rapid detection of mycobacteria in liquid medium is the BACTEC µGIT 960 system [2]. The system's culture tubes consist of modified Middlebrook 7H9 broth, a growth supplement, and an antimicrobial agent mixture. A similar principle is used in the ESP Culture System II and the MB/BacT system. In the BACTEC 960 system and ESP Culture System II, *M. tuberculosis* growth is detected by the rate of oxygen consumption within the headspace of the cultures; in the MB/BacT system, a colorimetric sensor detects the production of CO₂ dissolved in the culture medium.

5.6.4 Quality control of media

Quality control of the media is needed to ensure that the strain isolated from a specimen is from the patient and not a contaminant present in the ingredients of the medium. The description below mainly applies to quality control of solid media, as it is on such media that colonies are visible to the eye and species identification is therefore possible.

Commercially prepared media do not need to be quality controlled for sterility, growth and selectivity, provided that documentation of the manufacturer's quality control procedures is obtained [12]. The information should include the preparation date, the lot number, the expiration date, the test organisms used, the date of testing and the result. In all other cases (user-prepared media and when documentation of sterility, growth and selectivity is not provided), the media must be checked for:

- medium conditions: colour, dehydration, contamination, bubbles;
- sterility: incubating from 1–3% of each batch at 35–37°C in 5 to 10% CO₂ for up to 21 days;
- performance: by testing growth of positive and negative control strains.

The organisms used as positive controls are *M. tuberculosis* H37Ra (ATCC 25177), *M. kansasii* ATCC 12478, *M. scrofulaceum* ATCC 19981, *M. intracellulare* ATCC 13950 and *M. fortuitum* ATCC 2841. *Escherichia coli* ATCC 25922 is used to demonstrate partial inhibition by non-selective media and complete inhibition by selective media.

Procedure [1,2]:

- Prepare a 0.5 McFarland suspension of the organisms in 7H9 broth.
- Inoculate media with 10µl of the control suspension using a pipette or a calibrated loop. To test selective properties of the media, inoculate them with 10µl of 1:10 suspension in sterile 0.85% NaCl. Incubate all media at 35–37°C in 5–10% CO₂ for up to 21 days.
- Expected results are as follows:

Positive controls	Result
<i>M. tuberculosis</i> ATCC 25177	Growth on all media
<i>M. kansasii</i> ATCC 12478	Growth on all media
<i>M. scrofulaceum</i> ATCC 19981	Growth on all media
<i>M. fortuitum</i> ATCC 2841	Growth on all media
<i>M. intracellulare</i> ATCC 13950	Growth on all media (not included when testing selective media containing penicillin or carbenicillin)
Negative control	Result
<i>Escherichia coli</i> ATCC 25922	Partial inhibition in non-selective media, total inhibition in selective media

5.7 Culture tube inoculation

5.7.1 Solid media

In media that is purchased ready-to-use, condensed moisture is frequently observed on the culture slants and it is advisable to remove it before use. Each slant should be inoculated with 0.2–0.4 ml (2–4 drops or four loopfuls) of the centrifuged sediment. The use of sterile disposable Pasteur pipettes is highly recommended. The inoculum should be distributed over the entire surface of the slant.

At least two slopes of LJ medium per specimen should be inoculated with 0.2 ml of each sediment. In areas where *M. bovis* is isolated, an additional slope containing pyruvate is recommended. Using a ready-made commercially available egg-based media supplemented with antibiotic mixture may help to reduce contamination rates. Too little inoculum is a common cause of false-negative results. In the upper part of the slant the medium is thin and dehydrates readily; if mycobacteria are seeded only on this upper section, they might not grow, again leading to false-negative results.

5.7.2 Liquid media

Inoculation on liquid media should be performed under rigorous sterile conditions to avoid the risk of contamination. Liquid media is more susceptible to contamination than solid media and therefore needs to be supplemented with a mixture of specific antibiotics to kill the contaminants. These antibiotic mixtures are available from commercial companies selling culture media for automated culture systems.

Each properly labelled liquid culture tube should be inoculated with 0.5 ml of sediment and the sediment must be deposited under the surface of the medium, keeping the tube tilted at an angle of 45°. The tube is then returned to a vertical position, leaving the inoculum below the surface of the liquid.

5.8 Culture incubation

All cultures should be incubated at 35–37°C. Always check the temperature indicator before incubating the cultures. The cultures should be incubated until growth is observed, or discarded as negative after eight to 12 weeks (six weeks if liquid media is used).

Inoculated solid cultures should be incubated with caps loosened in a slanted position for at least one week to ensure an even distribution of the inoculum. Caps should then be tightened to prevent desiccation of the media and, if space is needed in the incubator, the tubes can be placed upright. Tops should be tightened to minimise evaporation which can result in the media drying out.

5.9 Culture examination

All cultures should be examined 48 hours after inoculation in order to:

- check absorption of inoculated liquid;
- tighten caps to prevent drying out of media; and
- detect early contaminants.

Cultures should then be examined on a weekly basis or, if this is not feasible, at least three times during the eight-week incubation period (Figure 6).

- Seven-day check: To detect rapidly growing mycobacteria.
- Three-to-four-week check to detect positive cultures of *M. tuberculosis* as well as other slow-growing mycobacteria.
- End of culture check (after eight weeks) to detect very slow-growing mycobacteria, including *M. tuberculosis*, before discarding and reporting the culture as negative.

Figure 6. Minimal examination schedule for solid cultures

(solid: weekly preferable)

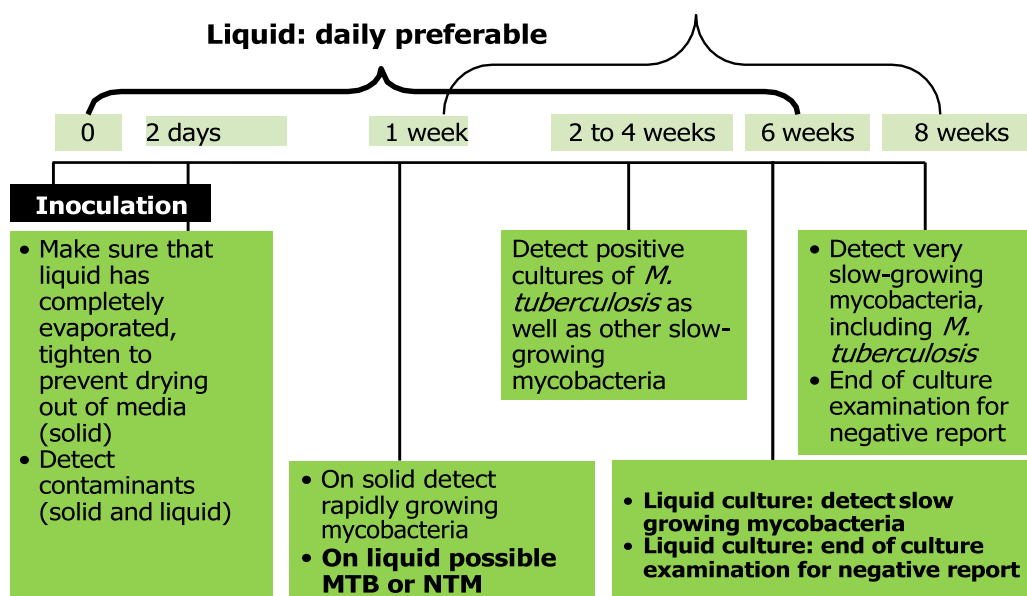

Source: Culture, DST and quality assurance package, WHO [14]

The different kinds of contaminants that should be considered are non-tuberculous mycobacteria, fungi, bacteria and yeasts.

After ZN staining, the culture should be handled according to the results:

- Presence of AFBs only in the deposit with no non-AFBs indicates pure growth of mycobacteria – the deposit should be processed for identification and drug susceptibility testing (inoculation of a non-selective agar plate, such as blood agar, can be used to check for purity).
- Presence of AFBs with non-AFBs in the deposit indicates contamination of the possible growth of mycobacteria – the deposit should be processed for decontamination and culture on solid media.
- No AFBs and only non-AFBs in the deposit indicate growth of contaminants – the deposit should be discarded.
- Any presence of contaminants should be recorded in the laboratory register and if the culture is discarded, it should be reported as a 'contaminated culture'.
- Evaluation of the contamination rate should be performed every three to six months for quality assurance purposes. A contamination rate of 3–5% is considered a good balance between the need to kill contaminating bacteria and the need to keep the majority of tubercular mycobacteria present in the sample. A contamination rate of 0–1% may indicate too strong a decontamination process. The contamination rate should refer to the number of contaminated tubes, not to the number of registered specimens.

Common contaminants are detailed below [4]:

Non-tuberculous mycobacteria:

- Fast- or slow-growers;
- Acid-fast bacilli;
- Not usually arranged in cords.

Fungi:

- Usually slow-growers;
- Non-acid-fast;
- Hyphae are thicker than mycobacteria.

Bacteria:

- Usually non-acid-fast except for some closely related genera (*Gordonia*, *Tsukamurella*, *Nocardia*, *Rhodococcus*, *Dietzia*) and *Legionella micdadei*.

Yeast:

- Usually non-acid-fast.

Oocystis:

- Usually non-acid-fast except for *Cryptosporidium*, *Isospora*, *Cyclospora*.

5.10 Chromatographic immunoassay for the qualitative detection of *Mycobacterium tuberculosis* complex from cultures

Assays used: Capilia TB-neo, TAUNS Laboratories Co, Shizuoka, Japan, BD µGIT TBc Identification Test, BD (Becton, Dickinson and Company) Diagnostic Systems, Sparks, MD, USA, and SD BIOLINE TB Ag MPB64 Rapid test, Abbott, Chicago, IL, USA.

5.10.1 Introduction

Definite diagnosis of TB can be made by identifying *M. tuberculosis* complex organisms from a clinical sample after growth in solid or liquid media. Since *M. tuberculosis* complex strains (with the exception of some sub-strains of *M. bovis* BCG) but not non-tuberculous mycobacteria specifically and predominantly secrete the MPB64 protein (mycobacterial protein fraction from BCG of Rm 0.64), this can be used to discriminate between *M. tuberculosis* complex and non-tuberculous mycobacteria. Immunochromatographic assays based on the reaction of monoclonal antibodies against MPB64 have been developed and evaluated [15-17].

5.10.2 Materials

No special equipment is required for the test; it is sufficient to use the test provided by the manufacturer, a 100 µl pipette, and a timer. The test consists of a sample placing area, a testing area containing the anti-MPB64 antibodies, and a control area where anti-species immunoglobulin antibodies are fixed.

5.10.3 Methods

The testing method is based on immunochromatographic principles, in which antibodies labelled with colloidal particles (such as colloidal gold) react with target antigens to form a migrating antigen-antibody complex, which is captured by a second fixed antibody. A colour reaction takes place where the labelled particles are fixed.

The tests can be used with positive liquid media tubes or visible colonies grown on solid media. In the case of liquid cultures, a 100 µl volume is dropped on to the test device. For solid cultures, 1 µl bacteria (=1 mm loop) or 1 AFB+ colony (at least 1 mm) are re-suspended in the respective buffer, then vortexed and a 100 µl volume of these suspensions is used. The results should be read after 15 minutes but within 60 minutes of contact.

5.10.4 Results interpretation

For a specific MPB64 antigen-antibody reaction, a red-purple colour band becomes visible within 15 minutes. The culture is interpreted as positive for *M. tuberculosis* complex if the colour reaction takes place in the test and control area. The intensities of the bands may vary. The specimen is interpreted as negative if a colour reaction takes place only in the control area. The test is invalid if no band is visible in the control area or if the background colour inhibits the test interpretation. Figure 7 gives examples of chromatographic immunoassays.

Although most *M. tuberculosis* complex strains may be correctly identified with the tests exhibiting a high sensitivity (92.4–99.2%) and specificity (100%), some test-negative strains have been isolated [16,17]. In some instances, the test misses the detection of *M. tuberculosis* (false negative result) as a result of mutations in the *mpb64* gene and consequent lack of secretion of the MPB64 protein in the culture media [17].

5.10.5 Biosafety

Appropriate biosafety precautions for handling mycobacteria must be used. The dropping procedure, development, and reading of the test should be carried out in an appropriate biological safety cabinet in a BSL 3 laboratory. As used test devices may contain viable mycobacteria, they should be discarded safely according to institutional guidelines for handling BSL-3 material (see Chapter 1).

Figure 7. Examples of chromatographic immunoassays for qualitative detection of *M. tuberculosis* complex

Capilia TB-neo

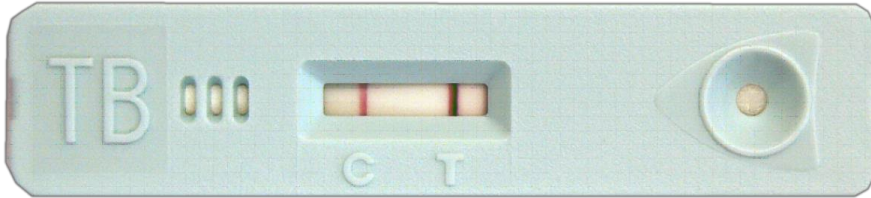

BD MGIT™ TBc Identification Test (TBc ID)

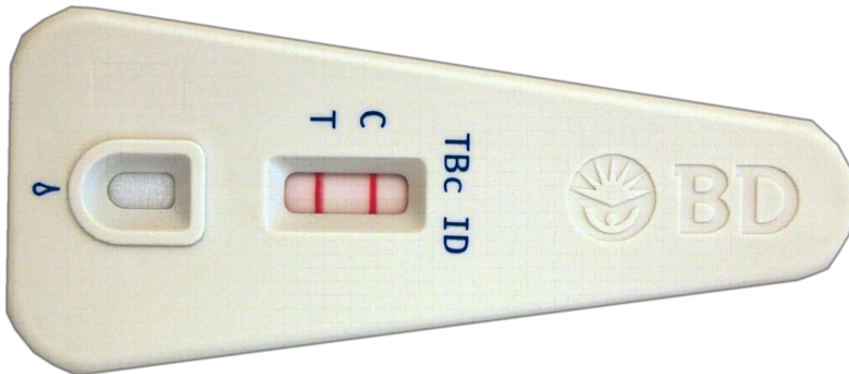

Developed with 100 µl of an AFB+ smear-positive liquid culture after 15 minutes incubation time.

References

1. Migliori GB, Zellweger JP, Abubakar I, Ibraim E, Caminero JA, De Vries G, et al. European Union standards for tuberculosis care. *Eur Respir J*. 2012 Apr;39(4):807-19
2. De Kantor IN, Kim SJ, Frieden T, Laszlo A, Luelfo F, Norval PY, et al. Laboratory services in tuberculosis control. WHO Global Tuberculosis Programme. WHO/TB/98.258. Geneva: WHO; 1998
3. Leão SC, Martin A, Mejia GI, Palomino JC, Robledo J, Telles MAS, et al. Practical handbook for the phenotypic and genotypic identification of mycobacteria. Antwerp: Institute of Tropical Medicine Antwerp; 2004.
4. Iseman MD. *A Clinician's Guide to Tuberculosis*. Philadelphia: Lippincott Williams & Wilkins, 2000.
5. Mase SR, Ramsay A, Ng V, Henry M, Hopewell PC, Cunningham J, et al. Yield of serial sputum specimen examinations in the diagnosis of pulmonary tuberculosis: a systematic review. *Int J Tuberc Lung Dis*. 2007 May;11(5):485-95.
6. Cirillo D, Piana F, Vincent V, Angra P, Barrera L, Boulahbal F, et al. Training package on culture of acid-fast bacilli and drug-susceptibility testing of *Mycobacterium tuberculosis*. In: Tuberculosis Control Assistance Program. TB CAP Toolbox – TB CAP Laboratory Tools [CD ROM]. n.p.; 2009.
7. World Health Organization (WHO). Guidance on regulations for the Transport of Infectious Substances 2013-2014. Applicable as from 1 January 2013. Geneva: WHO; 2012 Available at: http://www.who.int/ihr/publications/who_hse_ihr_2012.12
8. Vincent V, van Deun A, Feldmann K, Barrera L, Paramasivan CN, Weyer K, et al. Guidance for countries on the preparation and implementation of TB laboratory standard operating procedures (WHO SOPs). In: Tuberculosis Control Assistance Program. TB CAP Toolbox – TB CAP Laboratory Tools 2009 [CD ROM].
9. Health Protection Agency (HPA), Standards Unit, Evaluations and Standards Laboratory. Investigation of specimens for *Mycobacterium* species. London: HPA; 2006. Available at: <https://www.gov.uk/government/publications/smi-b-40-investigation-of-specimens-for-mycobacterium-species>
10. Richmond JY, McKinney RW. Primary Containment for Biohazards: Selection, Installation and Use of Biological Safety Cabinets. 2nd Edition. Washington: U.S. Department of Health and Human Services; 2000. Available at: http://www.who.int/ihr/training/laboratory_quality/3_cd_rom_bsc_selection_use_cdc_manual.pdf
11. Drobniewski FA, Hoffner S, Rusch-Gerdes S, Skenders G, Thomsen V; WHO European Laboratory Strengthening Task Force. Recommended standards for modern tuberculosis laboratory services in Europe. *Eur Respir J*. 2006 Nov;28(5):903-9.
12. World Health Organization (WHO). Laboratory biosafety manual – third edition. Geneva: WHO; 2004. Available at: http://www.who.int/csr/resources/publications/biosafety/WHO_CDS_CSR_LYO_2004_11
13. Tuberculosis Control Assistance Program. TB CAP Toolbox – TB CAP Laboratory Tools 2009 [CD ROM].
14. World Health Organization (WHO). Tuberculosis laboratory biosafety manual. Geneva: WHO; 2012. Available at: http://www.who.int/tb/publications/2012/tb_biosafety
15. Abe C, Hirano K, Tomiyama T. Simple and Rapid Identification of the *Mycobacterium tuberculosis* Complex by Immunochromatographic Assay using Anti-MPB64 Monoclonal Antibodies. *J Clin Microbiol*. 1999 Nov;37(11):3693-7.
16. Hillemann D, Rüscher-Gerdes S, Richter E. Application of the Capilia TB assay for culture confirmation of *Mycobacterium tuberculosis* complex isolates. *Int J Tuberc Lung Dis*. 2005 Dec;9(12):1409-11.
17. Hirano K, Aono A, Takahashi M, Abe C. Mutations Including IS6110 Insertion in the Gene Encoding the MPB64 Protein of Capilia TB-Negative *Mycobacterium tuberculosis* Isolates. *J Clin Microbiol*. 2004 Jan;42(1):390-2.

6 Molecular assays for TB and drug-resistant TB rapid detection

Doris Hillemann, Sarah Mitchell, Francis Drobniowski

Revised by Elisa Tagliani and Doris Hillemann (2022)

6.1 Background and principles

Over the past decade, molecular biology has gained a central role in the diagnosis of TB thanks to the development of new molecular tests, often referred to as nucleic acid amplification tests (NAATs). These assays rely on the amplification of targeted genes of *M. tuberculosis* complex enabling faster detection of TB and drug-resistant TB than conventional/culture-based methods. In addition, several NAATs are suitable to be performed at the more devolved levels of the health care system thus contributing to improving accessibility and quality of TB care.

This chapter provides an overview of the most commonly used molecular diagnostics for the rapid detection of TB and drug-resistant TB from culture and clinical specimens. In addition, it includes a description of the current applications of next generation sequencing (NGS) for drug susceptibility and resistance prediction starting from clinical specimens (i.e. targeted NGS) and culture isolates (i.e. whole genome sequencing).

6.2 Line probe assays

Line probe assays (LPAs) are a family of tests based on reverse-hybridisation DNA•STRIP technology. The procedure involves three steps: (i) DNA extraction from the decontaminated pulmonary specimens or cultured material (solid or liquid media); (ii) multiplex amplification with biotinylated primers; and (iii) reverse hybridisation.

The assay membrane strips are coated with specific probes complementary to the amplified nucleic acids. After chemical denaturation, the single-stranded amplicons bind to the probes (hybridisation). Highly specific binding of complementary DNA strands is ensured by stringent conditions thus allowing the probes to reliably discriminate several sequence variations in the gene regions examined. The streptavidin-conjugated alkaline phosphatase binds to the amplicons' biotin via the streptavidin group. Finally, the alkaline phosphatase transforms an added substrate into a dye which becomes visible on the membrane strips as a colored precipitate.

6.2.1 Line probe assays for *Mycobacterium* genus species identification

Several test options are available for the detection and differentiation of mycobacteria directly from clinical specimens (i.e. GenoType *cMdirect*) and cultivated samples (e.g. GenoType Mycobacterium CM / AS, GenoType NTM-DR) (Table 11).

Table 11. Types and specifics of LPAs used for detection and differentiation of *Mycobacteria*

Differentiation	
GenoType MTBC	Detection of <i>M. tuberculosis</i> complex from cultures
GenoType <i>cMdirect</i>	Detection of <i>M. tuberculosis</i> and 20 clinically relevant NTM from patient specimens
GenoType Mycobacterium CM	Detection of <i>M. tuberculosis</i> complex and more than 20 clinically relevant NTM from cultures
GenoType Mycobacterium AS	Detection of 19 additional NTM from cultures
Differentiation and drug susceptibility testing	
GenoType NTM-DR	Detection of important NTM and their resistance to aminoglycosides and macrolides from cultures
GenoType MTBDR <i>plus</i> V2	Detection of <i>M. tuberculosis</i> complex and resistance to rifampicin and isoniazid
GenoType MTBDR <i>s</i> /V2	Detection of <i>M. tuberculosis</i> complex and resistance to fluoroquinolones and aminoglycosides/cyclic peptides
LPA Genoscholar PZA-TB II	Detection of resistance to pyrazinamide in isolates from patients with bacteriologically confirmed pulmonary TB
Leprosy	
GenoType LepaeDR	Detection of <i>M. leprae</i> and its resistance to rifampicin, ofloxacin and dapsone from patient specimens

The GenoType series all use the same kit content including the membrane strips coated with specific probes, and various solutions for denaturation, hybridisation, washing, and colorimetric reaction. In addition, the kit includes the amplification mixes AM-A (containing buffer, nucleotides, and Taq polymerase) and AM-B (containing salts, specific primers, and dye).

Sample decontamination (e.g. with sodium hydroxide and NALC) and concentration of the specimen by centrifugation is required before DNA isolation. This procedure must be conducted following adequate biosafety requirements. DNA extraction can be performed using a kit (i.e. GenoLyse) produced by the same manufacturer.

Importantly, the preparation of the amplification reaction must be conducted in a laboratory dedicated pre-amplification area ('clean area') to reduce the risk of cross-contamination or carry-over contamination.

The amplification reaction relies on a standard protocol where the number of cycles varies depending on whether the test is performed directly on the clinical specimen or on a cultivated one.

The hybridisation reaction of the amplified products can be done manually using a water bath and TwinCubator, or automatically using for example a GT-Blot 48 machine. For the interpretation of the test results refer to the assay specific Interpretation Chart available in each kit (an example is provided below, Figure 8). For more detailed information on the assay procedure, refer to the specific instruction for use available in the kit and on the manufacturer website.

Figure 8. Interpretation sheet for GenoType cMdirect assay

Interpretation Chart

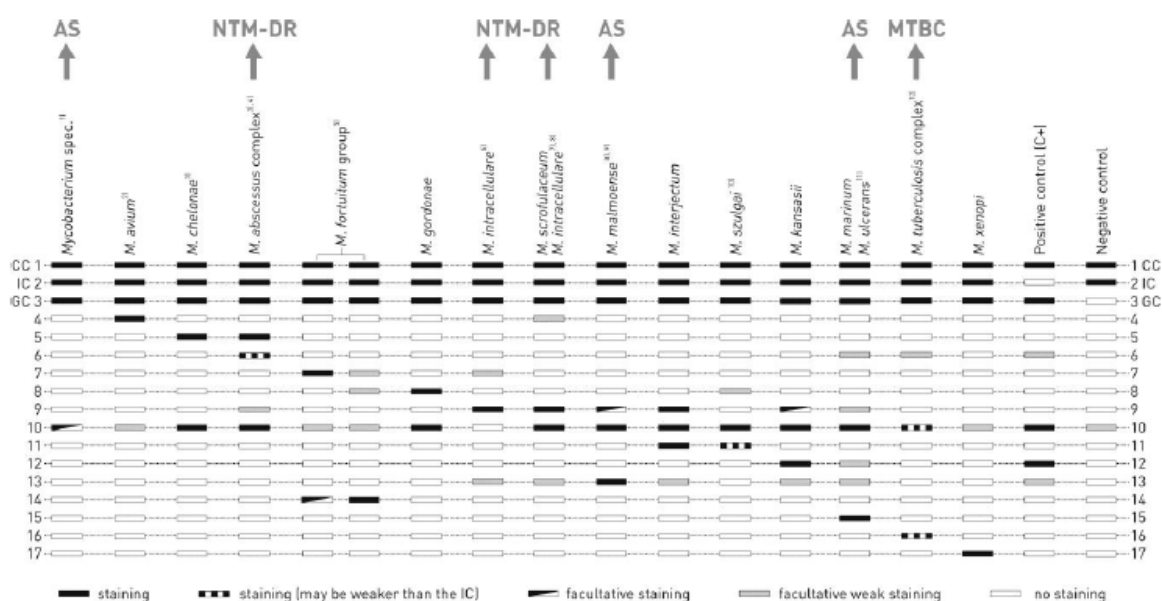

Band No. 1 (CC): Conjugate Control
Band No. 2 (IC): Internal Control
Band No. 3 (GC): Genus Control

AS: GenoType Mycobacterium AS (from cultured material)

MTBC: GenoType MTBC (from cultured material)

NTM-DR: GenoType NTM-DR (from cultured material)

6.2.2 Line probe assays for identification of *M. tuberculosis* complex and drug resistance detection from pulmonary clinical specimens and cultivated samples

The two most widely used LPAs for *M. tuberculosis* complex and drug resistance detection in the ERLTB Network are the GenoType MTBDR_{plus}V2 and GenoType MTBDR_sV2 assays (Bruker-Hain Lifescience, Nehren, Germany). In both cases, drug resistance is detected through the binding of amplicons to probes targeting the most common mutations to first- and second-line drugs or inferred by the lack of binding to wild-type probes.

They can be used for testing of smear-positive sputum specimens (i.e. GenoType MTBDR_{plus}) or of sputum specimens irrespective of the smear status (i.e. GenoType MTBDR_sV2), as well as on culture isolates (indirect testing) [1].

Given the complexity of the assay, the necessity of multiple pieces of equipment and the laboratory infrastructure requirements, LPAs are usually implemented at middle- and upper-tier health facilities. The use of LPAs allows obtaining drug susceptibility testing (DST) results in 24-48 hours.

The GenoType MTBDR_{plus} V2 assay allows the simultaneous detection of *M. tuberculosis* complex and resistance to rifampicin and isoniazid by targeting mutations in the *inhA* promoter (from -15 to -8 nucleotides upstream) and *katG* (codon 315) regions, and in the rifampicin resistance-determining region (RRDR) of the *rpoB* gene (from codon 424 to 452, *M. tuberculosis* H37Rv nomenclature) for rifampicin resistance [2].

The GenoType MTBDR_s/V2 assay allows the simultaneous detection of *M. tuberculosis* complex and resistance to fluoroquinolones (e.g. levofloxacin and moxifloxacin) and aminoglycosides/cyclic peptides (e.g. amikacin, kanamycin and capreomycin). The assay includes the quinolone-resistance determining region (QRDR) of *gyrA* (from codon 85 to 96) and *gyrB* (from codon 536 to 541) genes for detection of resistance to fluoroquinolones and the *rrs* (nucleic acid positions 1401, 1402 and 1484) and the *eis* promoter regions (from -37 to -2 nucleotides upstream) for detection of resistance to second line injectable agents [3].

The overall sensitivity and specificity of LPAs for different drugs are reported in detail in the WHO consolidated guidelines on TB, Module 3 [1].

In 2021, WHO recommended the use of the LPA Genoscholar PZA-TB II (Nipro) for detection of resistance to pyrazinamide in isolates from patients with bacteriologically confirmed pulmonary TB [1]. The assay targets a 700-base pair fragment covering the entire *pncA* coding region and 18 nucleotides upstream. The assay comprises a total of 48 probes including three probes that allow the detection of silent mutations not associated with pyrazinamide resistance. Resistance is inferred by the lack of binding to the wild-type probes. Practical considerations for implementation of the Nipro Genoscholar PZA-TB II assay are available in the Information sheet (Annex 2.6) of the WHO operational handbook on tuberculosis. Module 3: diagnosis [4].

As for the LPAs used for *Mycobacteria* identification and drug resistance detection, the testing procedure for this class of LPAs involves three steps including DNA extraction, multiplex amplification using biotinylated primers and reverse hybridisation on nitrocellulose strips.

Appropriate biosafety precautions must be taken when handling mycobacteria. The transfer of bacteria into tubes and heat inactivation during DNA preparation should be carried out in an appropriate biosafety cabinet in a BSL3 laboratory. Upon microorganisms' inactivation, the process can be continued outside the BSL3.

The preparation of the amplification reaction and the mix amplification protocol are identical to the ones described in section 6.2.1. More detailed information on the assay's procedures is provided in the kit instructions for use [2, 3].

The configuration of the of GenoType MTBDR_{plus} V2 and GenoType MTBDR_s/V2 strips is illustrated in Figure 9.

Practical guidance on the interpretation of the GenoType MTBDR assays including information of the association of specific mutations with phenotypic drug resistance, instances in which specific resistance-conferring mutations are not identified and resistance can only be inferred, actions to be performed when certain mutations are detected, and the clinical implications of specific LPA mutations for the selection of appropriate TB treatment is provided in the Global Laboratory Initiative/WHO document 'Line probe assays for detection of drug-resistant tuberculosis: interpretation and reporting manual for laboratory staff and clinicians' [5].

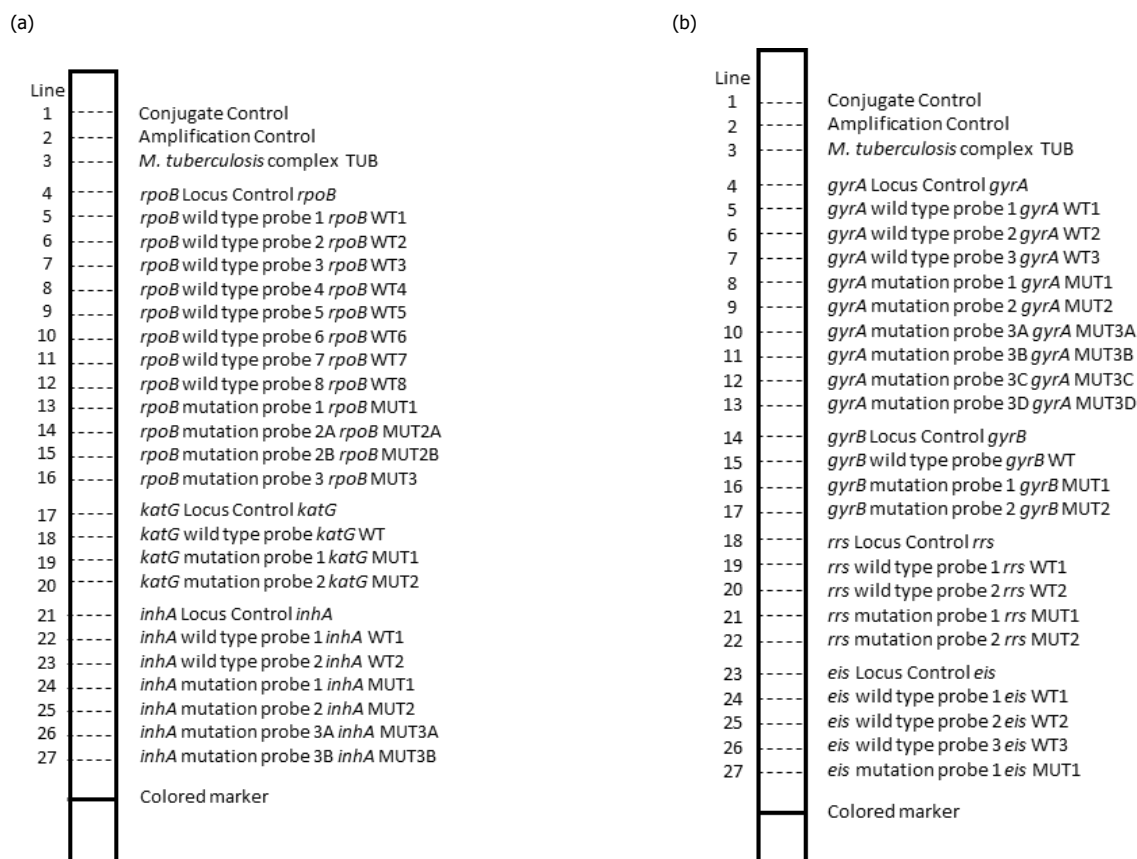
Figure 9. Configuration of GenoType MTBDRplus V2 (a) and GenoType MTBDRsl V2 (b) strips

6.3 Real time PCR-based assays for the identification of *M. tuberculosis* complex and drug resistance detection

The pipeline for new real time PCR based assays for diagnosis of TB with or without drug resistance detection has quickly progressed over the past years. WHO has recommended and supported the development and application of new rapid and accurate diagnostic methods focused on the simultaneous detection of *M. tuberculosis* complex and presence of drug resistance as the best strategy to advance TB laboratory diagnosis. Several WHO recommended rapid diagnostics (WRDs) are now providing options for different settings, but considerations on testing capacity, diagnostic yield, and feasibility of performing the test in the laboratory setting must be taken into account to ensure the diagnostic molecular method selected is appropriate for the specific clinical setting [6].

As an increasing number of WRDs serve similar purposes, WHO has grouped them into classes defined by the type of technology (e.g. automated or reverse hybridisation, nucleic acid amplification tests [NAATs]), the complexity of the test for implementation (e.g. low, moderate, or high – considering the requirements of infrastructure, equipment and technical skills of laboratory staff) and the target conditions (e.g. diagnosis of TB, and detection of resistance to first-line or second-line drugs) [4].

In this section we provide a description of the real-time PCR based assays most commonly used within the ERLTB Network including considerations on their key operational and implementation aspects. Reference and links to policy guidance documents, implementation manuals and training packages is also provided.

This section is not intended to provide the detailed description of the test procedure for which we refer to the specific instructions for use and operating manuals released by the assays' manufacturers.

6.3.1 Single-use sample-processing cartridge system with integrated multicolour real-time PCR capacity for detection of *M. tuberculosis* complex and drug resistance detection

Xpert MTB/RIF and Xpert MTB/RIF Ultra

Xpert MTB/RIF and Xpert MTB/RIF Ultra (Ultra) (Cepheid, Sunnyvale, USA) are cartridge-based real time PCR assays for the simultaneous detection of *M. tuberculosis* complex and rifampicin resistance from clinical specimens. These are fully automated assays as the cartridge contains all reagents required for bacterial lysis, nucleic acid extraction, amplification, and amplicon detection. The only manual step is the addition of a bactericidal lysis buffer to the specimen, which largely eliminates concerns about biosafety during the test procedure. Overall, the assays take approximately 2 hours from sample processing to automatic interpretation and release of the results.

The Xpert MTB/RIF and Xpert Ultra run on the same GeneXpert platform (i.e. six-colour optic instrument), as well as on the newly released 10-colour optic GeneXpert instrument [7].

The Xpert Ultra assay launched in 2017 as a next generation assay, has an increased sensitivity for *M. tuberculosis* complex detection compared to Xpert MTB/RIF as it targets two multicopy genes (IS6110 and IS1081) instead of one (*rpoB*) and it has a larger DNA reaction chamber, as well as improved fluidics and enzymes [8]. Xpert Ultra uses the same semi-quantitative categories for *M. tuberculosis* complex detection as the Xpert MTB/RIF (i.e. High, Medium, Low and Very Low), with the additional category 'trace' to identify the paucibacillary samples positive to IS6110/IS1081 targets but negative to *rpoB*. In this case no result for rifampicin susceptibility or resistance is provided.

Simultaneous detection of rifampicin resistance is achieved by targeting the RRDR of the *rpoB* gene. In the Xpert MTB/RIF assay, resistance is detected in case of lack or delayed binding of one or more of the five probes to the RRDR, while in the Xpert Ultra four sloppy molecular beacons have been designed to detect mutations by measurable shifts in the probes melting temperatures peaks. This results in an increased capacity of Xpert Ultra to detect mutations at specific codons (e.g. 452), to correctly identify mutations in mixed and paucibacillary samples, and to differentiate synonymous mutations from those associated with resistance [8].

Pooled sensitivities and specificities of Xpert Ultra and Xpert MTB/RIF for TB and drug resistance detection in pulmonary and extrapulmonary specimens in adult and children have recently been published [9-12]. Briefly, for pulmonary TB, Xpert Ultra pooled sensitivity and specificity against culture were 90.9% (86.2 to 94.7) and 95.6% (93.0 to 97.4), versus Xpert MTB/RIF pooled sensitivity and specificity of 84.7% (78.6 to 89.9) and 98.4% (97.0 to 99.3). For rifampicin resistance detection, the pooled sensitivity and specificity were 94.9% (88.9 to 97.9) and 99.1% (97.7 to 99.8) for Xpert Ultra versus 95.3% (90.0 to 98.1) and 98.8% (97.2 to 99.6) for Xpert MTB/RIF. A higher number of rifampicin resistance indeterminate results was detected with Xpert Ultra, pooled proportion 7.6% (2.4 to 21.0) compared to Xpert MTB/RIF pooled proportion 0.8% (0.2 to 2.4), with an estimated difference in the pooled proportions of indeterminate results for Xpert Ultra versus Xpert MTB/RIF of 6.7% (1.4 to 20.1)[1].

In 2020, WHO updated the recommendations on the use of Xpert MTB/RIF and Xpert Ultra as initial tests in adults and children with signs and symptoms of pulmonary and extrapulmonary TB [1]. Updated guidance on the interpretation of Xpert Ultra 'trace' result in HIV-negative people was also provided, recommending that an initial 'trace' call should be considered a true-positive result in those without a prior TB episode or a recent history of TB treatment. In these patients, it is no longer recommended repeating the Xpert Ultra test in case of a 'trace' positive result. In contrast, interpretation of 'trace' results in patients with previous TB may require further clinical assessment and additional tools to exclude a false-positive result. In the case of an indeterminate rifampicin result due to the low bacterial load in the specimen (i.e. MTB detected 'very low' or 'trace'), additional investigations should be performed to confirm or exclude resistance to the drug.

Xpert MTB/XDR

The Xpert MTB/XDR test (Cepheid, Sunnyvale, USA) detects *M. tuberculosis* complex DNA and genomic mutations associated with resistance to isoniazid, fluoroquinolones, ethionamide and second-line injectable drugs (amikacin, kanamycin and capreomycin) in a single cartridge, in approximately 90 minutes [13]. The sample processing procedure and cartridge handling are the same as for Xpert MTB/RIF and Xpert Ultra, however, the Xpert MTB/XDR runs on a 10-colour optics GeneXpert instrument instead of the six-colour optics traditionally used for Xpert MTB/RIF and Xpert Ultra testing. Xpert MTB/XDR targets the genes, codon regions and nucleotide sequences detailed in Table 12.

Table 12. Genes, codon regions and nucleotide sequences targeted by the Xpert MTB/XDR test

Drug	Gene target	Codon regions	Nucleotide
Isoniazid	<i>inhA</i> promoter	Not applicable	–1 to –32 intergenic region
	<i>katG</i>	311–319	939–957
	<i>fabG1</i>	199–210	597–630
	<i>oxyR-ahpC</i> intergenic region	Not applicable	–5 to –50 intergenic region (or –47 to –92) ^a
Ethionamide	<i>inhA</i> promoter	Not applicable	–1 to –32 intergenic region
Fluoroquinolones	<i>gyrA</i>	87–95	261–285
	<i>gyrB</i>	531–544 (or 493–505) ^a	1596–1632
Amikacin, kanamycin, capreomycin	<i>rrs</i>	Not applicable	1396–1417
Amikacin, kanamycin	<i>eis</i> promoter	Not applicable	–6 to –42 intergenic region

^a Codon numbering system according to Camus et al. (2002), as reported in Cepheid, Clinical evaluation of the Xpert MTB/XDR assay, Report R244C2 Xpert MTB/XDR Rev 1.0.

Xpert MTB/XDR assay is intended for use as a reflex test (a follow-up test automatically initiated by a clinical/microbiological laboratory when an initial test result meets pre-determined criteria; e.g. positive or outside normal parameters) in TB specimens, both unprocessed sputum and concentrated sputum sediments, determined to be positive for *M. tuberculosis* complex. The limit of detection for *M. tuberculosis* complex by Xpert MTB/XDR (136 cfu/mL in unprocessed sputum) is similar to that of Xpert MTB/RIF (112.6 cfu/mL), but higher than that of Xpert Ultra (15.6 cfu/mL). In the assay package insert is stated that specimens with a 'trace' result by Xpert Ultra are expected to be below the limit of detection of Xpert MTB/XDR assay and are thus not recommended for testing with this assay [14].

Mutations associated with resistance to isoniazid, fluoroquinolones, ethionamide, and second line injectables are detected by measurable shifts in the melting temperature peaks of the assay probes (i.e. sloppy molecular beacons). A detailed description of the assay design, development, and analytical performance has been published [15], while the diagnostic accuracy data for resistance detection to isoniazid, fluoroquinolones, ethionamide, and amikacin in people with TB detected by Xpert MTB/XDR derived from two multicentre studies have recently been reviewed [16].

Briefly, irrespective of rifampicin resistance, isoniazid resistance pooled sensitivity and specificity were 94.2% (87.5 to 97.4) and 98.5% (92.6 to 99.7) against phenotypic based DST, while fluoroquinolone resistance summary sensitivity and specificity were 93.2% (88.1 to 96.2) and 98.0% (90.8 to 99.6).

In people with known rifampicin resistance, ethionamide resistance summary sensitivity and specificity were 98.0% (74.2 to 99.9) and 99.7% (83.5 to 100.0) against genotypic based DST, while amikacin resistance summary sensitivity and specificity were 86.1% (75.0 to 92.7) and 98.9% (93.0 to 99.8) against phenotypic DST [16].

WHO recommendations on the use of Xpert MTB/XDR in people with bacteriologically confirmed pulmonary TB, with or without rifampicin resistance, are listed in the WHO consolidated guidelines, module 3: diagnosis, while additional considerations on the Xpert MTB/XDR operational features and implementation aspects are available in the information sheet (Annex 2.5) of the WHO operational handbook on tuberculosis. Module 3: diagnosis [4].

6.3.2 Chip-based real time micro-PCR for detection of *M. tuberculosis* complex and rifampicin resistance detection

Truenat MTB, MTB Plus and MTB-RIF Dx assays

The Truenat MTB, MTB Plus, and MTB-RIF Dx assays (Molbio Diagnostics, Goa, India) use chip-based real-time micro-PCR for the semiquantitative detection of *M. tuberculosis* complex (MTB and MTB Plus assays) and rifampicin resistance (MTB-RIF Dx assay) directly from sputum specimens (regardless of the smear status) and can report results in under an hour.

The Truenat testing system uses two portable, battery-operated devices, the Trueprep AUTO v2 Universal Cartridge based Sample Prep Device for the automated extraction and purification of DNA, and the Truelab Real Time micro-PCR Analyzer for performing real-time PCR. The system uses room temperature stable reagents (Trueprep™ AUTO Sample Pre-treatment and Prep kits) and Truenat micro PCR chips. The Truelab Analyzer is available with 1 (Uno)

chip port as well as with 2 (Duo) or 4 (Quattro) chip ports, which allow for independent testing of multiple samples at once. All reagents and consumables required for the test procedures are provided by the manufacturer, with the exception of personal protective equipment (same level of protection as required for microscopy or Xpert MTB/RIF), a timer, and hypochlorite-based disinfectant [17]. The system is designed to be operated in peripheral laboratories with minimal infrastructure requirements and can function at up to 40°C ambient temperature and up to 80% relative humidity [1].

Detection of *M. tuberculosis* complex by Truenat MTB is achieved by targeting a single copy gene (*nrdB*). The Truenat MTB Plus assay has a higher sensitivity than Truenat MTB as it targets multiple genes (*nrdZ* and IS6110). This results in a limit of detection of 30 cfu/ml for Truenat MTB Plus compared to 100 cfu/ml for Truenat MTB [17]. If a positive result is obtained with the MTB or MTB Plus assay, an aliquot of extracted DNA is run on the Truenat MTB-RIF Dx assay to detect mutations associated with RIF resistance. Resistance mutations are detected by a probe melt analysis of the real-time PCR products, which takes approximately an additional hour.

Detailed standard operating procedures for sputum sample preparation, DNA extraction and PCR amplification are described in the Stop TB Partnership Practical guide to Truenat tests implementation [17]. Briefly, DNA is extracted from pre-treated sputum specimens using the kit-specific cartridge and the Trueprep AUTO v2 Device. This process takes approximately 20 minutes. Automated PCR amplification and fluorescent probe-based detection of the extracted DNA on the Truelab Analyzer takes 35 minutes. Results of the Truenat MTB Plus are semiquantitative (i.e. MTB detected as high, medium, low, or very low).

WHO recommends using the Truenat MTB and MTB Plus assays in adults and children with signs and symptoms of pulmonary TB as an initial diagnostic test for TB rather than smear microscopy or culture. The Truenat MTB-RIF Dx is instead recommended for use in people with signs and symptoms of pulmonary TB and a Truenat MTB or MTB Plus positive result as an initial test for rifampicin resistance detection rather than culture and phenotypic DST [1]. Evidence reviewed by WHO on the use of the Truenat TB tests for the detection of *M. tuberculosis* complex and rifampicin resistance was generated through a multicenter prospective clinical evaluation study performed in the intended setting of use (i.e. microscopy centres). Compared to culture, the key performance characteristics of these tests among people with signs and symptoms of pulmonary TB are summarised in Table 13.

Table 13. Diagnostic accuracy of Truenat MTB, MTB Plus and MTB-RIF Dx tests relative to culture, in microscopy centre settings (derived by FIND evaluation study)[18]

Test	Sensitivity (all patients)	Sensitivity (SS+ patients)	Sensitivity (SS- patients)	Specificity (all patients)
Truenat MTB	0.73	0.91	0.37	0.98
Truenat MTB Plus	0.80	0.96	0.46	0.97
Truenat MTB-RIF Dx	0.84	0.88	0.67	0.95

SS+ = sputum smear positive; SS- = sputum smear negative

Interestingly, findings from this multicentre accuracy study also showed that the rate of rifampicin resistance indeterminate results varied depending on the specimen bacillary load, suggesting that the sensitivity of Truenat MTB Plus to detect MTB is likely higher than that of the Truenat MTB-RIF Dx chip to detect rifampicin resistance [18].

6.3.3 Centralised assays for *M. tuberculosis* complex detection and detection of resistance to rifampicin and isoniazid

A new class of technologies that allow for testing of different conditions using disease-specific assays on the same platform has recently come to market. Several manufacturers have developed moderate complexity automated nucleic acid amplification tests (NAATs) for detection of *M. tuberculosis* complex and resistance to rifampicin and isoniazid on these high throughput instruments. These assays are faster and less complex to perform than phenotypic culture-based DST and LPA as they are largely automated. However, they may require an initial manual specimen treatment step before the test material is transferred into the sample processing tube. Furthermore, adequate biosafety measures should be in place, as well as test-specific equipment, well trained and qualified laboratory staff to set up the tests and carry out the necessary equipment maintenance [1]. For reasons of cost and economy of scale, these assays are generally provided as a centralised service.

In 2019, WHO evaluated the accuracy of four different centralised assays for detection of *M. tuberculosis* complex detection and resistance to rifampicin and isoniazid [19, 20], and in 2020, issued recommendations for their use on respiratory samples as initial tests, rather than culture and phenotypic DST, for detection of *M. tuberculosis* complex and resistance to both rifampicin and isoniazid in people with sign and symptoms of pulmonary TB [1].

The four technologies and assays currently included in the moderate complexity automated NAATs class by WHO are: i) Abbott RealTime MTB and MTB RIF/INH assays, ii) Roche cobas MTB and MTB-RIF/INH assays, iii) Hain FluoroType MTBDR assay, and iv) BD MAX MDR-TB assay.

Based on the systematic review commissioned by WHO, the overall pooled sensitivity for *M. tuberculosis* complex detection compared to culture was 93.0% (90.9–94.7%) and specificity 97.7% (95.6–98.8%). Overall pooled sensitivity for detection of rifampicin resistance compared to phenotypic DST was 96.7% (93.1–98.4%) and specificity was 98.9% (97.5–99.5%), while overall pooled sensitivity for detection of isoniazid resistance compared to phenotypic DST was 86.4% (82.8–89.3%) and specificity was 99.2% (98.1–99.7%) [1, 21].

Abbott RealTime MTB and MTB RIF/INH assays

Abbott Molecular (Chicago, IL, USA) has one NAAT for detection of *M. tuberculosis* complex (RealTime MTB test) and one for the simultaneous detection of rifampicin and isoniazid resistance (RealTime MTB RIF/INH), which can be performed in a standalone mode (starting from the specimen) or in reflex mode (as follow up of the RealTime MTB test). The RealTime MTB test targets the multicopy gene IS6110 and the *pab* gene, while in the RealTime MTB RIF/INH, eight probes covering the RRDR of the *rpoB* gene detect mutations associated with resistance to rifampicin, and four probes detect mutations in the *katG* gene and *inhA* promoter region for isoniazid resistance. The reported limit of detection for *M. tuberculosis* complex is 17 cfu/ml, and 60 cfu/ml for drug resistance detection [1].

The assays are run on Abbot m2000 RealTime system, including two instruments, the m2000sp and m2000rt. Automated DNA extraction and PCR plate preparation starting from inactivated raw or processed sputum specimens is performed on the m2000sp. Alternatively, DNA can be manually extracted using the Abbott mSample Preparation System DNA kit, wherein cells are lysed and DNA is captured by magnetic microparticles. Then, the PCR plate is manually sealed and transferred to the Abbott m2000rt for real time PCR. The Abbot m2000 RealTime system allows for the high-throughput detection of *M. tuberculosis* complex (96 samples including two assay controls), with positive specimens reflexed to the MTB RIF/INH assay (24 samples including two assay controls) for full MDR-TB diagnosis within 10.5 hours.

Detailed information on the assays' procedure and analytical performances is available in the assays' instruction for use and instrument manuals provided by the manufacturer, and publicly available [22]. The accuracy and clinical performance of the Abbott-RT and Abbott-RIF/INH for the detection of TB and DR-TB have been evaluated in systematic reviews and prospective clinical studies [23-25]. Additional considerations on the operational capacity and implementation aspects of the test are available in the information sheet (Annex 2.1) of the WHO operational handbook on tuberculosis. Module 3: diagnosis [4].

Becton Dickinson MAX MDR-TB assay

Becton Dickinson (BD, Sparks, MD, USA) has a multiplexed real-time PCR assay (BD MAX MDR-TB) for the simultaneous detection of *M. tuberculosis* complex and resistance to both rifampicin and isoniazid that can be run on the BD MAX System (Figure 10). The test targets the multicopy genomic elements IS6110 and IS1081, as well as a single copy genomic target (*dev*) for *M. tuberculosis* complex detection, the RRDR of the *rpoB* gene (426 – 452) for rifampicin resistance detection and the *inhA* promoter region and the 315 codon of the *katG* gene for isoniazid resistance. The reported limit of detection is 0.5 cfu/ml for *M. tuberculosis* complex detection, and 6 cfu/ml for drug resistance detection [1].

The test is performed on the BD MAX platform, in which the DNA is automatically extracted starting from a pretreated NALC/NaOH decontaminated sputum (recommended option) or raw sputum, followed by real-time PCR. Bacterial cell lysis is done chemically and by heat, and the released DNA is then captured by magnetic affinity beads. Up to 24 samples can be tested per run on the computer-controlled benchtop system, with the automatic released of results within 4 hours. The assay includes master mixes, reagent strips, extraction tubes, sample tubes, transfer pipettes, and septum caps, while the sample pretreatment reagent (BD MAX STR) and PCR cartridges are provided separately.

Detailed information on the assay procedure and BD MAX System operation is provided in the assay instruction for use and User's Manual. The accuracy and clinical performance of the BD MAX MDR-TB assay have been evaluated in several prospective clinical studies [26-29]. Additional considerations on the operational capacity and implementation aspects of the test are available in the Information sheet (Annex 2.2) of the WHO operational handbook on tuberculosis. Module 3: diagnosis [4].

Figure 10. BD MAX system at the National Research Center, Borstel, Germany

Roche cobas MTB and cobas MTB-RIF/INH assays

Roche Molecular Systems, Inc. (RMS, Roche, Basel, Switzerland) has two NAATs, the cobas MTB and the cobas MTB-RIF/INH tests, to detect *M. tuberculosis* complex and resistance to rifampicin and isoniazid, respectively. The MTB assay uses real-time PCR for *M. tuberculosis* complex detection by targeting the 16S rRNA and five *esx* genes (*esxJ*, *esxK*, *esxM*, *esxP*, *esxW*) starting from inactivated human respiratory samples, including raw and NALC-NaOH-treated sputum and bronchoalveolar lavage fluid. It can generate results for 96 tests (including assay controls) in a 3.5 hour run. The MTB-RIF/INH assay targets the RRDR of *rpoB* gene for rifampicin resistance and the *inhA* promoter region and the *katG* gene for detection of resistance to isoniazid. This assay can be used as a reflex test of cobas MTB-positive samples providing the rifampicin and isoniazid resistance profile for up to 96 samples (including assay controls) in an additional 3.5 hours. The limit of detection reported by the company for this test is 7.6 cfu/ml for decontaminated sediments and 8.8 cfu/ml for unprocessed sputum [1].

The tests are run on the cobas 6800/8800 Systems, which automatically extract DNA for qualitative real-time PCR. Prior to running the cobas MTB or the cobas MTB-RIF/INH assays on the cobas 6800/8800 Systems, samples must be inactivated using the manufacturer specific solution followed by sonication and centrifugation for which additional instrumentation is needed. Therefore, bacterial cell lysis is done chemically (lysis reagent), enzymatically (proteinase) and physically (sonication). Subsequently, the released bacterial DNA is captured by magnetic glass particles and undergoes amplification. Fluorescent-labelled probes allow for the specific detection of the MTB and RIF/INH targets.

Detailed information on the assay procedure and cobas 6800/8800 Systems operation is provided in the assay instruction for use and User's Manuals. The accuracy and clinical performance of the cobas MTB and cobas MTB-RIF/INH tests have been evaluated in several prospective clinical studies [30-32]. Additional considerations on the operational capacity and implementation aspects of these tests are available in the Information sheet (Annex 2.3) of the WHO operational handbook on tuberculosis. Module 3: diagnosis [4].

Bruker-Hain Lifesciences FluoroType MTB and FluoroType MTBDR assays

Bruker-Hain Diagnostics has two real-time nucleic acid amplification tests, the FluoroType MTB and the FluoroType MTBDR to detect *M. tuberculosis* complex and resistance to rifampicin and isoniazid, respectively. The assays use the LATE-PCR amplification and lights-on/lights-off chemistry and target the IS6110 DNA insertion element for *M. tuberculosis* complex detection (FluoroType MTB), and the *rpoB* gene, the *inhA* promoter and *katG* gene for detection of *M. tuberculosis* complex and associated resistance to rifampicin and isoniazid, respectively (FluoroType MTBDR) [1].

The assays run on the FluoroCycler System. Two platforms with different throughput capacity are currently available: the FluoroCycler 12 for the amplification and detection of up to 12 samples and the FluoroCycler XT, which allows the testing of up to 96 samples (including assays controls) and provides results within 4 hours (Figure 11). The limit of detection reported by the company for *M. tuberculosis* complex detection by FluoroType MTB (version 2) is 2.6 cfu/ml and 9 cfu/ml by FluoroType MTBDR, while for rifampicin and isoniazid resistance detection is 14 cfu/ml [1].

Bacterial nucleic acids extraction from decontaminated sputum specimens (FluoroType MTB), or decontaminated sputum specimens and culture isolates (FluoroType MTBDR), can be performed manually using the specific kit provided by the manufacturer (FluorLyse) or be fully automated using the GenoXtract instrument. This allows for the processing of up to 96 samples as well as the preparation of the PCR plate, which is then transferred on the FluoroCycler XT instrument. DNA extraction by GenoXtract relies on the capturing of intact cells to magnetic beads, from where the cells are washed and then lysed. Both assays use a high-resolution melt curve analysis to detect and automatically report fluorescent detection associated with the probes specific for the *M. tuberculosis* complex and drug resistance targets. The assay differentiates between high-level and low-level isoniazid resistance, and the FluoroSoftware automatically reports the specific mutations identified for each gene target, including mutations that are rare or are associated with unknown resistance profiles.

Detailed information on the procedure and FluoroCycler System operation is provided in the assay instruction for use and User's Manuals available upon request to the manufacturer. The accuracy and clinical performance of the FluoroType MTB and FluoroType MDRTB tests assays have been evaluated in prospective clinical studies [33, 34]. Additional considerations on the operational capacity and implementation aspects of these tests are available in the Information sheet (Annex 2.4) of the WHO operational handbook on tuberculosis. Module 3: diagnosis [4].

Figure 11. FluoroCycler XT at the Ospedale San Raffaele TB Supranational Reference laboratory, Milan, Italy



6.4 Next generation sequencing based approaches for drug-resistant tuberculosis detection

Next generation sequencing (NGS) has emerged as a powerful tool to improve TB management and control through the rapid, accurate, and comprehensive detection of clinically relevant mutations. This is crucial for clinicians to make prompt decisions regarding the best treatment options, in particular for patients with multi- and extensively drug-resistant TB. Furthermore, NGS-based DST overcomes many of the limitations of the currently available molecular assays which target only a limited number of genomic regions for the testing of a restricted number of drugs, often do not provide information on the specific mutation detected and have limited ability to detect subpopulations of resistant organisms including heteroresistance.

Rapid, reliable and increasingly affordable NGS technologies can now guide all components of TB control, from international surveillance of prevalence and drug-resistant TB to determination of the species or subspecies of *M. tuberculosis* complex isolates and their resistance profile based on the identification of single nucleotide

polymorphisms (SNPs), as well as the identification of transmission clusters and outbreaks investigation in different settings (see chapter 8 on molecular typing).

Several comprehensive reviews have been recently published describing the current landscape of NGS applications and recent developments of NGS as a tool for the diagnosis and clinical management of TB [35, 36].

In 2018, WHO published a technical guide that summarises the characteristics of available NGS technologies and provides guidelines for NGS technology selection, procurement and implementation by TB reference laboratories in low- and middle-income countries for the diagnosis of drug-resistant TB in clinical samples [37]. In 2021 WHO published a catalogue of mutations to serve as a global standard for interpreting molecular information for drug resistance prediction [38], and an updated version is expected in early 2023.

In this section, we focus on the two most used NGS workflows for *M. tuberculosis* complex drug resistance prediction: whole genome sequencing and targeted-NGS.

6.4.1 Whole genome sequencing

Whole genome sequencing (WGS) approaches use NGS platforms to reconstruct the complete DNA sequence of the bacterial genome allowing the identification of SNPs and insertions/deletions (indels) within regions associated with resistance to anti-TB drugs. The generated data not only allow for the prediction of drug-resistant or -sensitive phenotype, that can be used to inform treatment decisions, but also contribute to our understanding of novel resistance mechanisms for both current and newer drugs as well as to the identification of compensatory mutations.

Currently, WGS is generally performed starting from bacterial strains grown in culture due to the need for a relatively high quantity of good quality high molecular weight DNA. Regardless of the platform and/or chemistry employed for sequencing, WGS workflow is subdivided into four main steps: 1) high molecular weight DNA extraction and quantification; 2) library preparation (including DNA fragmentation, adapter linkage, and PCR amplification); 3) automated single- or paired-end NGS leading to the generation of millions of reads; 4) data analysis. The first three steps are often referred to as the 'wet' laboratory portion of the process while the bioinformatics step as the 'dry' laboratory portion. Detailed information on each of these steps can be found in the WHO technical guide on NGS for *M. tuberculosis* complex [37].

Multiple sequence data analysis solutions exist that differ widely in scope, pipelines and output formats, with little standardisation among them [35]. Generally, sequencing analysis for *M. tuberculosis* complex involves input data validation and quality control, followed by mapping to a reference genome (e.g. *M. tuberculosis* H37Rv) and detection of genomic variants including SNPs and indels. This could be done using a variety of free online tools (e.g. TB profiler, PhyReSE, Mykrobe predictor TB, etc.) [39], or alternatively using commercial software or in-house developed pipelines, some of which are available in public repositories such as GitHub. For a more detailed description of in-house pipelines refer to available publications [40,41,35,42].

In general, as clinical decisions such as the design of the most appropriate treatment regimen rely on the bioinformatic analysis of the sequencing data, it is crucial to use robust and validated pipelines for drug resistance prediction. Resistance profiling is achieved by comparing *M. tuberculosis* complex mutations detected to published curated up-to-date databases such as the WHO catalog of mutations in *M. tuberculosis* complex [38]. This is the largest catalogue of TB mutations that has been developed to date, with a total of 17 000 mutations, the inclusion of more than 38 000 *M. tuberculosis* isolates, with phenotypic DST results and WGS data contributed from 41 countries [43]. Efforts to expand the current catalogue with gene regions and mutations implicated in resistance to newer drugs are ongoing.

Several publications on examples of integration of WGS-based systems into routine TB diagnostic algorithms in selected high-income settings in Europe and North America, including the benefits and clinical impact of WGS on treatment decisions are now available [44-47].

6.4.2 Targeted next generation sequencing

An alternative approach for obtaining a comprehensive resistance profile is the design of rapid, targeted genomic panels that include only genes known to be involved in drug-resistance. This approach allows to bypass the need for *M. tuberculosis* complex culture as it can be performed directly on primary specimens, which is invaluable to reference laboratories because it reduces the time to TB and DR-TB diagnosis and the costs associated to culture [37].

Targeted NGS requires the pre-existing knowledge of the targets (i.e. known resistance markers) but it has the advantage of being customisable and scalable to include additional targets of interest. Furthermore, it allows to interrogate specific regions in the bacterial genome with a higher depth of coverage (i.e. deep/ultra-deep sequencing) thus offering high confidence for mutation detection, also enabling the detection of mixed populations and heteroresistance, within a sample. An additional advantage is that compared to WGS, targeted NGS is much less data intensive and requires significantly less data storage [36].

A few end-to-end solutions for targeted NGS-based DR-TB diagnosis running on both Illumina and Oxford Nanopore platforms are currently being evaluated in a Unitaid funded project (Seq&Treat) coordinated by FIND (<https://www.genomeweb.com/Reprint-GW22009FIND>). Importantly, evidence from this project will inform WHO policy on the use of targeted NGS for DR-TB diagnosis.

One of these technologies is the Deeplex Myc-TB assay (Genoscreen, Lille, France) (CE-IVD), a 24-amplicon mix that has capacity to screen for mutations in 18 genes known to be associated with *M. tuberculosis* complex resistance to 15 anti-TB drugs including the new and repurposed drugs bedaquiline, clofazimine and linezolid, allowing the simultaneous detection of mycobacterial species identification and genotyping. Samples can be pooled and analysed in a single bench top NGS platform run (e.g. up to 48 samples including controls on an Illumina MiSeq). The targeted NGS workflow includes five steps: 1) DNA extraction from a decontaminated and heat inactivated specimen; 2) multiplex amplification including clean-up of amplicon mixtures and quantification; 3) library preparation including tagmentation, amplification, clean-up and quantification; 4) sequencing; 5) data analysis [37]. The kit is linked to a secured cloud-based application, for fast and easy analysis and interpretation of the sequencing data. More detailed information on the procedure is available in the kit User Manual.

Figure 12. Deeplex-MycTB Workflow

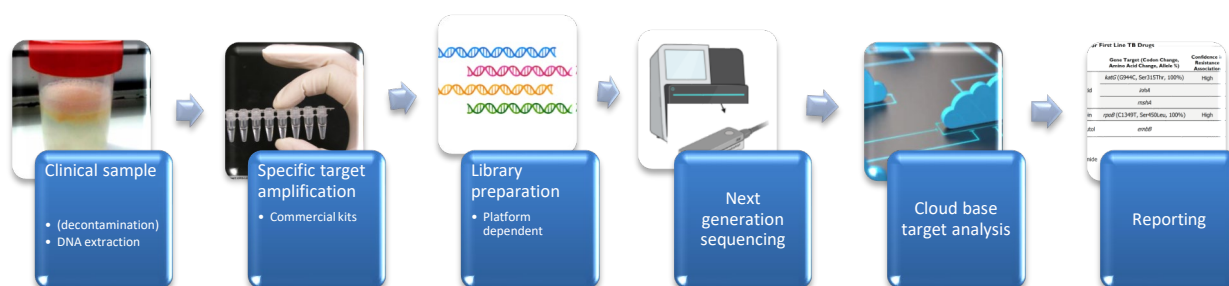

References

1. World Health Organization (WHO). WHO consolidated guidelines on tuberculosis. Module 3: diagnosis – rapid diagnostics for tuberculosis detection, 2021 update. Available at: <https://www.who.int/publications/i/item/9789240029415>
2. Hain Lifescience. GenoType MTBDRplus VER 2.0 Molecular Genetic Assay for Identification of the *M. tuberculosis* Complex and its Resistance to Rifampicin and Isoniazid from Clinical Specimens and Cultivated samples Instructions for use (April 2019).
3. Hain Lifescience. GenoType MTBDRsl VER 2.0. Molecular Genetic Assay for Identification of the *M. tuberculosis* Complex and its Resistance to Fluoroquinolones and Aminoglycosides/Cyclic Peptides from Sputum Specimens or Cultivated Samples. Instruction for use (December 2017).
4. World Health Organization (WHO). WHO operational handbook on tuberculosis. Module 3: diagnosis - rapid diagnostics for tuberculosis detection, 2021 update. Geneva: World Health Organization; 2021. Licence: CC BY-NC-SA 3.0 IGO. Available at: <https://www.who.int/publications/i/item/9789240030589>
5. World Health Organization (WHO). Global Laboratory Initiative. Line probe assays for detection of drug-resistant tuberculosis: interpretation and reporting manual for laboratory staff and clinicians. Licence: CC BY-NC-SA 3.0 IGO. Available at: <https://www.who.int/publications/i/item/9789240046665>
6. World Health Organization (WHO). Global Laboratory Initiative. Manual for selection of molecular WHO-recommended rapid diagnostic tests for detection of tuberculosis and drug-resistant tuberculosis. Licence: CC BY-NC-SA 3.0 IGO. Available at: <https://www.who.int/publications/i/item/9789240042575>
7. World Health Organization (WHO). Use of Xpert MTB/RIF and Xpert MTB/RIF Ultra on GeneXpert 10-colour instruments: WHO policy statement. Licence: CC BY-NC-SA 3.0 IGO
8. Chakravorty S, Simmons AM, Rowneki M, Parmar H, Cao Y, Ryan J, et al. The new Xpert MTB/RIF Ultra: improving detection of *Mycobacterium tuberculosis* and resistance to rifampin in an assay suitable for point-of-care testing. *MBio*. 2017 08;8(4).
9. Kohli M, Schiller I, Dendukuri N, Yao M, Dheda K, Denkinge CM, et al. Xpert MTB/RIF Ultra and Xpert MTB/RIF assays for extrapulmonary tuberculosis and rifampicin resistance in adults. *Cochrane Database Syst Rev*. 2021 01 15;1:CD012768.
10. Shapiro AE, Ross JM, Yao M, Schiller I, Kohli M, Dendukuri N, et al. Xpert MTB/RIF and Xpert Ultra assays for screening for pulmonary tuberculosis and rifampicin resistance in adults, irrespective of signs or symptoms. *Cochrane Database Syst Rev*. 2021 03 23;3:CD013694.
11. Zifodya JS, Kreniske JS, Schiller I, Kohli M, Dendukuri N, Schumacher SG, et al. Xpert Ultra versus Xpert MTB/RIF for pulmonary tuberculosis and rifampicin resistance in adults with presumptive pulmonary tuberculosis. *Cochrane Database Syst Rev*. 2021 02 22;2:CD009593.
12. Kay AW, Ness T, Verkuijl SE, Viney K, Brands A, Masini T, et al. Xpert MTB/RIF Ultra assay for tuberculosis disease and rifampicin resistance in children. *Cochrane Database Syst Rev*. 2022 09 06;9:CD013359.
13. Chakravorty S, Roh SS, Glass J, Smith LE, Simmons AM, Lund K, et al. Detection of Isoniazid-, Fluoroquinolone-, Amikacin-, and Kanamycin-Resistant Tuberculosis in an Automated, Multiplexed 10-Color Assay Suitable for Point-of-Care Use. *J Clin Microbiol*. 2017 01;55(1):183-98.
14. Cepheid. Xpert MTB/XDR Instruction for use (302-3514, Rev. B July 2020).
15. Cao Y, Parmar H, Gaur RL, Lieu D, Raghunath S, Via N, et al. Xpert MTB/XDR: a 10-Color Reflex Assay Suitable for Point-of-Care Settings To Detect Isoniazid, Fluoroquinolone, and Second-Line-Injectable-Drug Resistance Directly from *Mycobacterium tuberculosis*-Positive Sputum. *J Clin Microbiol*. 2021 02;59(3).
16. Pillay S, Steingart KR, Davies GR, Chaplin M, De Vos M, Schumacher SG, et al. Xpert MTB/XDR for detection of pulmonary tuberculosis and resistance to isoniazid, fluoroquinolones, ethionamide, and amikacin. *Cochrane Database Syst Rev*. 2022 05 18;5:CD014841.
17. Stop TB Partnership. Practical Guide to Implementation of Truenat™ Tests for the Detection of TB and Rifampicin Resistance (version 2, March 2021). Available at: https://stoptb.org/assets/documents/resources/publications/sd/Truenat_Implementation_Guide.pdf
18. Penn-Nicholson A, Gomathi SN, Ugarte-Gil C, Meaza A, Lavu E, Patel P, et al. A prospective multicentre diagnostic accuracy study for the Truenat tuberculosis assays. *Eur Respir J*. 2021 10;58(5).
19. World Health Organization (WHO). WHO Meeting Report of a Technical Expert Consultation: Accuracy of centralized assays for TB detection and detection of resistance to rifampicin and isoniazid. WHO/CDS/TB/2019.14. Licence: CC BY-NC-SA 3.0 IGO.
20. Vos M, Scott L, David A, Trollip A, Hoffmann H, Georghiou S, et al. Comparative Analytical Evaluation of Four Centralized Platforms for the Detection of *Mycobacterium tuberculosis* Complex and Resistance to Rifampicin and Isoniazid. *J Clin Microbiol*. 2021 02 18;59(3).
21. Kohli M, MacLean E, Pai M, Schumacher SG, Denkinge CM. Diagnostic accuracy of centralised assays for TB

- detection and detection of resistance to rifampicin and isoniazid: a systematic review and meta-analysis. *Eur Respir J*. 2021 02;57(2).
22. Kostera J, Leckie G, Tang N, Lampinen J, Szostak M, Abravaya K, et al. Analytical and clinical performance characteristics of the Abbott RealTime MTB RIF/INH Resistance, an assay for the detection of rifampicin and isoniazid resistant *Mycobacterium tuberculosis* in pulmonary specimens. *Tuberculosis (Edinb)*. 2016 12;101:137-43.
 23. Scott L, David A, Noble L, Nduna M, Da Silva P, Black A, et al. Performance of the Abbott RealTime MTB and MTB RIF/INH Assays in a Setting of High Tuberculosis and HIV Coinfection in South Africa. *J Clin Microbiol*. 2017 08;55(8):2491-501.
 24. Wang MG, Xue M, Wu SQ, Zhang MM, Wang Y, Liu Q, et al. Abbott RealTime MTB and MTB RIF/INH assays for the diagnosis of tuberculosis and rifampicin/isoniazid resistance. *Infect Genet Evol*. 2019 07;71:54-59.
 25. Araya BT, Ali KE, Geleta DA, Tekele SG, Tulu KD. Performance of the Abbott RealTime MTB and RIF/INH resistance assays for the detection of *Mycobacterium tuberculosis* and resistance markers in sputum specimens. *PLoS One*. 2021;16(5):e0251602.
 26. Ciesielczuk H, Kouvas N, North N, Buchanan R, Tiberi S. Evaluation of the BD MAX™ MDR-TB assay in a real-world setting for the diagnosis of pulmonary and extra-pulmonary TB. *Eur J Clin Microbiol Infect Dis*. 2020 Jul;39(7):1321-27.
 27. Hofmann-Thiel S, Plesnik S, Mihalic M, Heiß-Neumann M, Avsar K, Beutler M, et al. Clinical Evaluation of BD MAX MDR-TB Assay for Direct Detection of *Mycobacterium tuberculosis* Complex and Resistance Markers. *J Mol Diagn*. 2020 10;22(10):1280-86.
 28. Shah M, Paradis S, Betz J, Beylis N, Bharadwaj R, Caceres T, et al. Multicenter Study of the Accuracy of the BD MAX Multidrug-resistant Tuberculosis Assay for Detection of *Mycobacterium tuberculosis* Complex and Mutations Associated With Resistance to Rifampin and Isoniazid. *Clin Infect Dis*. 2020 08 22;71(5):1161-67.
 29. Sağiroğlu P, Atalay MA. Evaluation of the performance of the BD MAX MDR-TB test in the diagnosis of *Mycobacterium tuberculosis* complex in extrapulmonary and pulmonary samples. *Expert Rev Mol Diagn*. 2021 Dec;21(12):1361-67.
 30. Scott L, David A, Govender L, Furrer J, Rakgokong M, Waja Z, et al. Performance of the Roche cobas MTB Assay for the Molecular Diagnosis of Pulmonary Tuberculosis in a High HIV Burden Setting. *J Mol Diagn*. 2020 10;22(10):1225-37.
 31. Nadarajan D, Hillemann D, Kamara R, Foray L, Conteh OS, Merker M, et al. Evaluation of the Roche cobas MTB and MTB-RIF/INH Assays in Samples from Germany and Sierra Leone. *J Clin Microbiol*. 2021 04 20;59(5).
 32. Aono A, Murase Y, Minegishi M, Ohtawa S, Yano M, Chikamatsu K, et al. Clinical evaluation of the cobas® MTB-RIF/INH reagent and the cobas® 6800 for the detection of isoniazid and rifampicin resistance. *Tuberculosis (Edinb)*. 2022 05;134:102199.
 33. Vos M, Derendinger B, Dolby T, Simpson J, van Helden PD, Rice JE, et al. Diagnostic Accuracy and Utility of FluoroType MTBDR, a New Molecular Assay for Multidrug-Resistant Tuberculosis. *J Clin Microbiol*. 2018 09;56(9).
 34. Dippenaar A, Derendinger B, Dolby T, Beylis N, van Helden PD, Theron G, et al. Diagnostic accuracy of the FluoroType MTB and MTBDR VER 2.0 assays for the centralized high-throughput detection of *Mycobacterium tuberculosis* complex DNA and isoniazid and rifampicin resistance. *Clin Microbiol Infect*. 2021 Sep;27(9):1351.e1-51.e4.
 35. Meehan CJ, Goig GA, Kohl TA, Verboven L, Dippenaar A, Ezewudo M, et al. Whole genome sequencing of *Mycobacterium tuberculosis*: current standards and open issues. *Nat Rev Microbiol*. 2019 09;17(9):533-45.
 36. Dookie N, Khan A, Padayatchi N, Naidoo K. Application of Next Generation Sequencing for Diagnosis and Clinical Management of Drug-Resistant Tuberculosis: Updates on Recent Developments in the Field. *Front Microbiol*. 2022;13:775030.
 37. World Health Organization (WHO). The use of next-generation sequencing technologies for the detection of mutations associated with drug resistance in *Mycobacterium tuberculosis* complex: technical guide. 2018 (WHO/CDS/TB/2018.19). Licence: CC BY-NC-SA 3.0 IGO. Available at: <http://apps.who.int/iris/bitstream/handle/10665/274443/WHO-CDS-TB-2018.19-eng.pdf>
 38. World Health Organization (WHO). Catalogue of mutations in *Mycobacterium tuberculosis* complex and their association with drug resistance. Licence: CC BY-NC-SA 3.0 IGO. Available at: <https://www.who.int/publications/i/item/9789240028173>
 39. Schleusener V, Köser CU, Beckert P, Niemann S, Feuerriegel S. *Mycobacterium tuberculosis* resistance prediction and lineage classification from genome sequencing: comparison of automated analysis tools. *Sci Rep*. 2017 Apr;7:46327.
 40. Kohl TA, Utpatel C, Schleusener V, De Filippo MR, Beckert P, Cirillo DM, et al. MTBseq: a comprehensive pipeline for whole genome sequence analysis of. *PeerJ*. 2018;6:e5895.
 41. Jajou R, Kohl TA, Walker T, Norman A, Cirillo DM, Tagliani E, et al. Towards standardisation: comparison of

- five whole genome sequencing (WGS) analysis pipelines for detection of epidemiologically linked tuberculosis cases. *Euro Surveill.* 2019 Dec;24(50).
42. Bogaerts B, Delcourt T, Soetaert K, Boarbi S, Ceyskens PJ, Winand R, et al. A Bioinformatics Whole-Genome Sequencing Workflow for Clinical *Mycobacterium tuberculosis* Complex Isolate Analysis, Validated Using a Reference Collection Extensively Characterized with Conventional Methods and. *J Clin Microbiol.* 2021 05 19;59(6).
 43. Walker TM, Miotto P, Köser CU, Fowler PW, Knaggs J, Iqbal Z, et al. The 2021 WHO catalogue of *Mycobacterium tuberculosis* complex mutations associated with drug resistance: A genotypic analysis. *Lancet Microbe.* 2022 04;3(4):e265-e73.
 44. Shea J, Halse TA, Lapierre P, Shudt M, Kohlerschmidt D, Van Roey P, et al. Comprehensive Whole-Genome Sequencing and Reporting of Drug Resistance Profiles on Clinical Cases of *Mycobacterium tuberculosis* in New York State. *J Clin Microbiol.* 2017 06;55(6):1871-82.
 45. Cabibbe AM, Trovato A, De Filippo MR, Ghodousi A, Rindi L, Garzelli C, et al. Countrywide implementation of whole genome sequencing: an opportunity to improve tuberculosis management, surveillance and contact tracing in low incidence countries. *Eur Respir J.* 2018 06;51(6).
 46. Park M, Lalvani A, Satta G, Kon OM. Evaluating the clinical impact of routine whole genome sequencing in tuberculosis treatment decisions and the issue of isoniazid mono-resistance. *BMC Infect Dis.* 2022 Apr 07;22(1):349.
 47. Soetaert K, Ceyskens PJ, Boarbi S, Bogaerts B, Delcourt T, Vanneste K, et al. Retrospective evaluation of routine whole genome sequencing of *Mycobacterium tuberculosis* at the Belgian National Reference Center, 2019. *Acta Clin Belg.* 2022 Oct;77(5):853-60.

7 Phenotypic susceptibility testing to anti-tuberculous agents for *Mycobacterium tuberculosis* complex

Emmanuelle Cambau, Sabine Rüsç-Gerdes

Revised by Emmanuelle Cambau, Jim Werngren, Margaret Fitzgibbon, and Daniela Maria Cirillo (2022)

7.1 Background and principles

This chapter describes phenotypic antimicrobial susceptibility testing (AST) for *Mycobacterium tuberculosis* and other members of the *M. tuberculosis* complex (MTBC) [1, 2].

Major objectives for AST in MTBC include: (i) ensuring effective individual treatment and management of a TB case; (ii) anti-tuberculosis drug resistance surveillance at the level of a hospital, city, region, or country; (iii) identification of the need for isolation of patients; and (iv) determination of the scope of institutional and community outbreak investigations required [1, 2]. The implementation of the WHO End TB Strategy requires provision of susceptibility data for all patients with signs and symptoms of TB [3].

Because of the development of antimicrobial resistance (AMR) in TB worldwide, rapid and reliable AST to antituberculous agents is required. Specimens for culture and AST should be obtained at or before the start of treatment and testing should be performed rapidly for at least rifampicin and isoniazid. Baseline susceptibility testing for fluoroquinolones would be highly recommended for patients coming from countries with a high prevalence of resistance to fluoroquinolones in new TB patients [4]. AST may be repeated if the patient is still culture positive after two months of treatment [5].

The AMR rates for antituberculous agents are higher in re-treatment cases (acquired resistance or secondary resistance) than in new cases (primary resistance), the difference varying according to the country or epidemiological situation [6]. AMR observed during treatment, designated as 'acquired' or 'secondary resistance', results from the selection and multiplication of resistant mutant subpopulations pre-existing in the tubercle bacillus isolate before therapy. AMR observed before treatment, designated as 'primary resistance', is the consequence of exposure to a drug-resistant source of infection [7].

Identification of the mycobacterial culture or MTBC acid-fast bacilli is necessary before AST is undertaken to avoid false resistant results due to the presence of non-tuberculous mycobacteria (NTM) which may have similar growth patterns but harbour intrinsic resistant characteristics. The knowledge of the exact MTBC species and in some cases the lineage is important when interpreting the AST results, as some strains show intrinsic resistance to a drug (e.g. *M. bovis* and *M. canettii* being resistant to pyrazinamide [8, 9]), or increased MIC values for a specific drug (e.g. Lineage 1 strains having increased MIC values of pretomanid [10]).

Laboratories should only use reliable methods for MTBC AST using the WHO-recommended drug critical concentrations [11-13]. The laboratory should have considerable experience in the chosen method, and it should be carried out by skilled technicians. It is also extremely important to periodically perform internal and external quality controls (QC) for AST. According to ISO 15189 (standards 5.3.2), all new reagents (lot or shipment) should be verified for performance before being used, therefore, all batches of media (LJ and MGIT), as well as the other reagents used for AST should be tested. If the lot/batch QC fails, all results obtained within that batch, as well as the new batch of a reagent should be thoroughly reviewed, and the testing might be repeated. All laboratories performing AST have to participate in an external QC programme [1, 14].

AST is usually performed on MTBC cultures (indirect testing) but it could also be performed on specimens containing acid-fast bacilli known to belong to MTBC (direct testing) [15] as long as special conditions are fulfilled as described in section 7.3.3. Results are obtained faster for direct testing; however, there is a lower rate of success due to possible contamination or wrong estimation of the inoculum.

Given the high risk of generating infectious aerosols from specimens and the high concentration of infectious particles, all procedures described in this chapter should be performed in a high risk (TB-containment BSL3) laboratory [16].

7.2 General method – AST by culture

7.2.1 Definitions

Critical concentration: the lowest concentration of an anti-TB agent that will inhibit the in vitro growth of 99% of phenotypically wild type isolates of *M. tuberculosis* complex.

Critical proportion: the proportion of resistant organisms within a particular cultured isolate that is used to determine resistance to a particular drug. Any culture that shows less than 1% growth on a medium containing a critical concentration of the agent being tested when compared with the growth on a control without the agent is considered to be susceptible; a culture that has 1% or more growth on the medium containing the critical concentration of the agent is considered to be resistant.

Minimum inhibitory concentration (MIC): the lowest concentration of an antimicrobial agent that prevents visual growth of the isolate in a solid medium or broth dilution susceptibility test, under specific conditions of testing (see EUCAST reference protocol below).

Clinical breakpoint: the concentration/s of an antimicrobial agent equal or above the critical concentration that separates isolates that will likely respond to treatment (S categorisation) from those which will likely not respond to treatment (R categorisation). This concentration is determined by correlation with available clinical outcome data, MIC distributions, genetic markers, and pharmacokinetic/pharmacodynamic data including drug dose. An increase dosing can be used in some defined cases (I categorisation). The clinical breakpoint is used to guide individual clinical decisions in patient treatment.

Epidemiological cut-off value (ECOFF): the upper end of the Gaussian-shaped MIC distribution of a species when only phenotypically wild-type (pWT) isolates are tested. The ECOFF typically encompasses 99% of pWT isolates [17].

Growth control: Number of colonies obtained upon inoculation of dilutions of the mycobacterial suspension in a culture medium that does not contain any anti-TB agent.

Resistance is defined as a decrease in sensitivity of sufficient degree to be reasonably certain that the strain concerned is different from drug susceptible wild-type reference strains. In this case, desired clinical effect of the drug is unlikely.

Susceptibility is defined by a level of sensitivity not significantly different from wild-type strains that have never come into contact with the drug. In this case, expected clinical responsiveness by the use of the drug is likely [18, 19].

7.2.2 Introduction

The methods introduced in this chapter aim not only to detect resistance but also to assess susceptibility [19, 1, 2]. Applying these methods should lead to high sensitivity for detecting resistance (i.e. a low rate of false susceptibility results) and high specificity (i.e. a low rate of false-resistance results). Additionally, these methods should also offer high sensitivity for assessing susceptibility (i.e. a low rate of false-resistance results) and a high specificity (i.e. a low rate of false susceptible results). Performance studies on the various methods are referenced in each method section.

Phenotypic DST methods rely on the use of critical concentrations of anti-TB agents. Definitions and usefulness of critical concentrations as well as other cut-off values (clinical breakpoints, MICs and epidemiological cut-off values) in phenotypic DST have considerably evolved over the last decade and are considered in detail elsewhere [20, 21, 2].

In 2021, WHO published a technical report with the revised critical concentrations for culture-based phenotypic AST to first-line anti-TB drugs isoniazid and rifampicin [13]. Critical concentrations for rifampicin have been lowered while those for isoniazid have been maintained at the present level. This update helps addressing the discordance observed between phenotypic and molecular methods to detect rifampicin resistance and improves the accuracy of AST [13]. The updated concentrations are reported in Table 14. All concentrations are in mg/L and apply to the proportion method with 1% as the critical proportion. Slightly different critical concentrations are provided by the Clinical and Laboratory Standards Institute (CLSI) [22].

Table 14. Critical concentrations for isoniazid and the rifamycins [13]

Medicine	LJ	7H10	7H11	MGIT
Isoniazid	0.2	0.2	0.2	0.1
Rifampicin	40.0	0.5	1.0	0.5
Rifabutin	-	-	-	-
Rifapentine	-	-	-	-

LJ = Löwenstein–Jensen medium; 7H10 = Middlebrook 7H10 growth medium; 7H11 = Middlebrook 7H11 growth medium; MGIT = Mycobacteria Growth Indicator Tube

In 2021, WHO recommended the use of a four-month regimen for drug-susceptible TB composed of rifapentine, isoniazid, pyrazinamide, and moxifloxacin [23]. Given the lack of available minimum inhibitory concentration (MIC) data for rifapentine, according to WHO, complete cross-resistance with rifampicin should be assumed until sufficient data to the contrary become available (i.e. genotypic AST and phenotypic AST results for rifampicin should be used as the surrogate for rifapentine) [13].

Drugs for the treatment of rifampicin-resistant (RR)/multidrug-resistant (MDR) TB are grouped by WHO based on their relative benefits and harms into [24]:

- **Group A:** fluoroquinolones (levofloxacin and moxifloxacin), bedaquiline and linezolid (considered highly effective and strongly recommended for inclusion in all regimens unless contraindicated);
- **Group B:** clofazimine and cycloserine or terizidone (conditionally recommended as agents of second choice);
- **Group C:** all other medicines that can be used when a regimen cannot be composed with Group A and B agents. The medicines in Group C (ethambutol, delamanid, pyrazinamide, imipenem-cilastatin/ meropenem, amikacin, ethionamide/prothionamide, *P*-aminosalicylic acid) are ranked by the relative balance of benefit to harm usually expected of each.

In May 2022, WHO released a rapid communication stating that the six-months all-oral regimen of bedaquiline, pretomanid, linezolid, and moxifloxacin (BPaLM) may be used programmatically for patients (aged ≥ 15 years) with rifampicin-resistant TB not yet exposed to bedaquiline, pretomanid (not categorised), and linezolid. This regimen may be used without moxifloxacin (BPaL) in the case of documented resistance to fluoroquinolones (in patients with pre-XDR-TB) [25]. Given this new recommendation, building capacity to perform AST to bedaquiline and linezolid has become an urgent priority.

For many of the recommended drugs for use in the longer RR/MDR-TB treatment regimen, there are no validated AST protocols described yet, and acquired resistance under treatment is not well characterised.

The critical concentrations and clinical breakpoints for medicines recommended for the treatment of rifampicin-resistant and multidrug-resistant TB according to WHO are reported in Table 15. All concentrations are in mg/L and apply to the proportion method with 1% as the critical proportion.

Table 15. Critical concentrations and clinical breakpoints for medicines recommended for the treatment of RR/MDR-TB [24]

Groups and steps	Medicine	LJ	7H10	7H11	MGIT
Group A: Include all three medicines	Levofloxacin	2.0	1.0	-	1.0
	Moxifloxacin (CC)	1.0	0.5	0.5	0.25
	Moxifloxacin (CB)	-	2.0	-	1.0
	Bedaquiline	-	-	0.25	1.0
	Linezolid	-	1.0	1.0	1.0
Group B: Add one or both medicines	Clofazimine	-	-	-	1.0
	Cycloserine / terizidone	-	-	-	-
Group C: Add to complete the regimen and when medicines from Groups A and B cannot be used	Ethambutol	2.0	5.0	7.5	5.0
	Delamanid	-	-	0.016	0.06
	Pyrazinamide	-	-	-	100.0
	Imipenem–cilastatin	-	-	-	-
	Meropenem	-	-	-	-
	Amikacin	30.0	2.0	-	1.0
	Ethionamide	40.0	5.0	10.0	5.0
	Prothionamide	40.0	-	-	2.5
<i>P</i> -aminosalicylic acid	-	-	-	-	

LJ = Löwenstein–Jensen medium; 7H10 = Middlebrook 7H10 growth medium; 7H11 = Middlebrook 7H11 growth medium; MGIT = *Mycobacteria Growth Indicator Tube*

For pretomanid, a provisional breakpoint of 1 mg/L using the MGIT System has been proposed by the European Medicines Agency (EMA) [26], while EUCAST has proposed 2 mg/L as a provisional screen value to be used for AST in MGIT (EUCAST, September 2022) until sufficient MIC data using the EUCAST reference method is available (<http://www.eucast.org>). WHO has not yet endorsed a critical concentration for this drug.

7.2.2 Materials

For direct testing: smear-positive specimens after classical decontamination (see Section 5.6) should be used [15].

For indirect testing: clinical isolates of MTBC, as a positive liquid culture or colonies on a solid media, after checking for purity should be used [1, 27].

7.2.3 Methods

In this chapter we will focus on the AST methods primarily used in the ERLTB-Network, namely the proportion method on both solid media (i.e. Löwenstein-Jensen) [28] and liquid Middlebrook (7H9) media using the BD BACTEC MGIT automated mycobacterial detection system [29-32]. In addition, we will describe the EUCAST reference method for minimum inhibitory concentration (MIC) determination used to define epidemiological cut-off values (ECOFFs) and clinical breakpoints (CBs) [33, 34].

Other solid culture methods (i.e. the resistance ratio method and the absolute concentration method) are still used, although rarely, in some laboratories as they are relatively inexpensive. However, these methods have been standardised for testing of first-line drugs only (rifampicin, isoniazid, ethambutol and pyrazinamide) [35].

Several additional phenotypic assays, such as the nitrate reductase assay (NRA), microplate microdilution using resazurin (colorimetric redox indicator assay, CRI) or commercial plate (Sensititre MYCOTB MIC plate), microscopic observed direct susceptibility testing (MODS) and the Thin Layer Agar methods (TLA) are less reproducible than the proportion methods. WHO has endorsed the use of the NRA and MODS assays for direct AST, and the NRA, MODS and CRI assays for indirect AST, in reference laboratories under clearly defined operational conditions following strict laboratory protocols [36]. These methods have been described and recently reviewed elsewhere [37-43].

7.2.4 Report/interpretation

Reporting of susceptibility results is easily done for each tested drug, if the method was performed according to the standard protocol. Unexpected resistant results should be checked by molecular confirmation, as described in Chapter 6 or by repeated testing. This may be done as soon as a resistance pattern is observed. If a mutation known to confer resistance is observed, this confirms resistance. Conversely, if no mutation in the genes known to confer resistance is detected, this implies that the strain needs to be retested with a reference method. If the strain still appears resistant but no mutation is found, colonies growing in the presence of the particular antibiotic should be retested [8].

Emergency and priority reporting should be carried out for cases of smear-positive pulmonary TB and for all cases detected as RR/MDR-TB. These results should be reported according to the institutional protocol, preferably to the attending clinical team. Routine reporting should contain the start date of testing and the date of reporting.

For antibiotics for which several concentrations can be tested, the level of resistance can be determined and reported [44]. Usually, a report of low resistance does not imply that the drug will not be given; conversely, a report of a high-level of resistance implies that the drug is of no clinical use. However, more clinical studies should be done correlating patient outcome with levels of resistance.

7.3 Proportion method on Löwenstein-Jensen medium

7.3.1 Introduction

The proportion method on Löwenstein-Jensen (LJ) medium was one of the first methods developed for susceptibility testing of MTBC and it is still considered a reference method. Subsequently, it was adapted to be used with other media such as the Middlebrook agar (7H10 or 7H11) as described in the WHO technical manual for drug susceptibility testing [11]. It should be emphasised that anti-TB drug critical concentrations may be different between the media (see Tables 14 and 15) [13, 45].

The proportion method calculates the proportion of resistant bacilli present in the clinical isolate [35]. In this method, the growth (i.e. the number of colonies) on a control LJ tube that does not contain an anti-TB agent (i.e. growth control) is compared with the growth present on LJ tubes containing the critical concentration of the anti-TB drug being tested. In general, at least two dilutions of a culture suspension are tested on both the growth control and the drug containing tube. The ratio of the number of colonies on the medium containing the anti-TB agent to the number of colonies on the medium without the anti-TB agent is calculated, and the proportion is expressed as a percentage. Below a critical proportion of 1%, the strain is classified as susceptible; above that proportion, it is classified as resistant (see section 7.2.1). The critical proportion was assessed by a study of a cohort of patients in the 1960s who failed TB treatment [18] and is particularly useful for patients in whom heteroresistance is suspected. The proportion method on LJ media is well established for first-line (i.e. rifampicin, isoniazid, ethambutol) and some second-line drugs (i.e. levofloxacin, moxifloxacin, amikacin, ethionamide/prothionamide).

7.3.2 Materials

For direct testing, smear-positive specimens are decontaminated as per the usual procedure (see Section 5.4.1.) and the sediment is used either pure or diluted.

For indirect testing, a pure, well-characterised culture of *M. tuberculosis* complex (MTBC) bacteria in the active growth phase is necessary.

LJ tubes (preferably with screw caps) with the incorporated anti-TB agent to be tested, and LJ tubes without any anti-TB agent. Pure formulation (no patient tablets) of the anti-TB drugs being tested must be always used. Other materials include sterile pipettes and McFarland turbidity standard no. 1.

7.3.3 Methods

Media preparation

A detailed description of the procedure used for the preparation of LJ media for AST is available in the WHO technical manual for drug susceptibility testing of medicines used in the treatment of TB [11]. For the preparation of the medium containing the agent to be tested, the agents are incorporated into the liquid mixture according to their specific critical concentrations before the media is dispensed into tubes and inspissated. LJ medium with and without incorporated drugs can be stored at 4–8 °C for one month.

Drugs

The drugs to be tested should be stored according to the manufacturer's instructions. Substances, solvents and diluents are listed in Table 16 along with critical concentrations for testing on LJ media.

Table 16. Solvents and diluents

Drugs	Substance	Critical concentration in LJ (mg/l)	Solvents	Diluents
Isoniazid	Isoniazid	0.2	DW	DW
Rifampicin	Rifampicin	40	DMSO	DW
Ethambutol	Ethambutol dihydrochloride	2	DW	DW
Amikacin	Amikacin sulfate	40	DW	DW
Levofloxacin	L-ofloxacin	2	0.1N NaOH	DW
Moxifloxacin	Moxifloxacin	1	0.1N NaOH	DW

DW = Sterile distilled water; DMSO = dimethyl-sulfoxide; NaOH = Sodium-hydroxide.

Bacterial suspension and inoculation

Indirect drug susceptibility testing

This is carried out on a primary isolate or a subculture on LJ medium. A representative portion of the isolate is obtained by sampling as many colonies as possible within one or two weeks after the appearance of growth.

The colonies are transferred to a glass tube or an Erlen flask without residual culture medium. Homogenisation of the suspension can be done using glass beads (3.0 mm in diameter) or with a glass rod with a molten rounded tip by rubbing the bacteria onto the glass wall. The suspension is then made by adding 0.9% sodium chloride or distilled water. After thorough mixing and homogenisation of the suspension, the tubes should rest for ten minutes, after which the supernatant is pipetted into another tube.

The turbidity of the suspension should be visually adjusted to 1 mg wet bacterial mass/ml (about one full loop with an inner diameter of 3 mm), or to the reference suspension McFarland standard 1.0 (9.9 ml sulphuric acid [1% volume concentration] with 0.1 ml barium chloride solution [1% mass concentration]). The latter is about 10-fold less concentrated than the former.

Serial dilutions of 10^{-1} to 10^{-5} of the standard suspension are prepared by diluting sequentially 1.0 ml of the standard suspension in tubes containing 9 ml of sterile distilled 0.9% sodium chloride.

Usually, two dilutions of the inoculum are inoculated onto the control LJ tubes (without drug), the second inoculum being a 1:100-fold dilution of the first inoculum: 10^{-1} and 10^{-3} of the 1 mg/ml suspension, or 10^{-2} and 10^{-4} of the Mc Farland 1.0.

The drug containing LJ tubes are then inoculated with the two dilutions. The volume of the inoculum in both the control and drug containing tubes is 0.1 ml.

Direct testing using primary specimens

Decontaminated smear-positive specimens are inoculated directly onto LJ slopes using two dilutions, as for the indirect testing, the second inoculum being a 1:100 dilution of the first inoculum. Dilutions are made according to the number of acid-fast bacilli per microscopic field (x1 000 magnification):

- Undiluted (inoculum 1) and 10^{-2} (inoculum 2) if there is less than 1 AFB per field;
- 10^{-1} and 10^{-3} if there are 1 to 10 AFB per field;
- 10^{-2} and 10^{-4} if there are more than 10 AFB per field.

The drug containing LJ media tubes are inoculated with both dilutions if possible, or at least with dilution 1 for first-line drugs (1% critical proportion) and dilution 2 for the second-line drugs amikacin and moxifloxacin. The volume of the inoculum is 0.1 ml per tube.

Incubation

After inoculation, the tubes are incubated at $36\pm 1^\circ\text{C}$ in a slanted position, with the screw caps slightly loosened to allow for the evaporation of the inoculum. This does however depend on the type of screw caps; those that can be closed immediately after inoculation may be preferred. After 2 to 4 days, screw caps are tightened, and the tubes are further incubated.

7.3.4 Report interpretation

The following three steps are used for reading the results:

- Counting of the colonies grown on the growth control tubes. For dilution 1 (e.g. 10⁻²) a confluent growth is often observed since circa 10⁴ colony-forming units (CFU) have been inoculated; for dilution 2 (e.g. 10⁻⁴) about 20–100 colonies are counted. This number may differ from strain to strain since some are dysgonic (i.e. grow with difficulty on the culture media);
- Counting of the colonies grown on the LJ tubes containing the anti-TB agent being tested. Usually the first dilution (i.e. 10⁻² dilution) is used for counting.
- Calculation of the proportion of resistant bacilli by comparing the counts on growth control dilution 2 (i.e. 10⁻⁴ dilution) with the counts on the tubes containing the anti-TB agent (usually dilution 1). If the proportion is equal or above 1 %, the strain is reported as resistant; if the proportion is below 1%, the strain is reported as susceptible.

The reading of results is carried out after 28 days (early reading) and 42 days (final reading) after inoculation. If after four weeks of incubation the proportion of resistant colonies is higher than the critical proportion, the strain can be reported as resistant. Also, if the reading on day 28 shows that there are no colonies on the drug containing media and the colonies on the control tubes are mature, the strain can be reported as susceptible. Except for these two instances, all other results should be reported after the reading on day 42.

If the number of colonies in the control tubes inoculated with inoculum 1 is below to 100, the test should be repeated with a less diluted inoculum.

7.4 Drug susceptibility testing in liquid media (Bactec MGIT 960)

7.4.1 Introduction

The first liquid-based culture media were introduced commercially in the 1990s, and several evaluations have demonstrated good correlation with the solid media proportion method and significant time savings. One of the earlier disadvantages of this system was the use of a radioactive labelled substrate. Because of the strict regulations of handling and waste disposal of radioactive material along with the biosafety aspects of using syringes for bacterial inoculation, it became necessary to develop a non-radiometric broth-based technique.

Two liquid culture systems for AST are currently commercially available: the BACTEC MGIT 960 system (Becton Dickinson, Sparks, MD, USA) and the VersaTREK™ automated microbial detection system (Thermo Fisher Scientific, Waltham, MA, USA). The BACTEC MGIT 960 system uses 7H9 liquid media which contains an oxygen-quenched fluorochrome embedded in silicone at the bottom of the culture tube. During bacterial growth, the free oxygen in the medium is utilised and replaced with carbon dioxide. With the depletion of free oxygen, the fluorochrome is no longer inhibited, resulting in fluorescence and identification of bacterial growth (measured as growth units, GU), which can be detected manually or automatically [30, 32, 46-47].

7.4.2 Materials

For the inoculum preparation, a pure, well-characterised culture of *M. tuberculosis* bacteria in the active growth phase is required. Other material required include BACTEC MGIT culture tubes, growth supplements and drugs. Drugs are supplied either in lyophilised form or as pure powders by vendors and must be reconstituted following the manufacturer instructions making sure that the final test concentrations are the same as those recommended by WHO.

7.4.3 Methods

Media preparation

A total of 0.1 ml of a reconstituted drug solution and 0.8 ml supplement (e.g. OADC, consisting of oleic acid, albumin, dextrose and catalase) (available commercially) is added to each of the 7 ml of 7H9 media-containing tubes.

Drugs

Ready to use AST kits for first line drugs and pyrazinamide are commercially available (i.e. BACTEC MGIT 960 SIRE and IRE kits and BACTEC MGIT 960 PZA kit). Recently, Becton Dickinson has made lyophilised preparations available for second-line drugs like amikacin and moxifloxacin for use in the MGIT 960 as well as in other media. Other second line drugs (e.g. Linezolid and Clofazimine) are supplied by specific manufacturers (e.g. Sigma-Aldrich, Caymen Chemical). New drugs such as Bedaquiline and Delamanid can only be procured through official

suppliers (i.e. NIH AIDS Reagent Program³, and BEI resources⁴, respectively). Drugs must be properly reconstituted to provide critical concentrations recommended by WHO (Tables 14 and 15). Detailed information on how to prepare the drugs stock and working solutions are available in the WHO technical manual on drug susceptibility testing [11].

Table 17. Second line drugs solvents, diluents and concentrations for AST in MGIT

Drugs	Stock solution concentration (mg/L)	Solvent	Diluent	Working solution concentration (mg/L)	Final concentration in MGIT (mg/L)
Levofloxacin	10 000	0.1N NaOH ¹	DW	84.0	1.0
Moxifloxacin (CC)	10 000	0.1N NaOH ¹	DW	21.0	0.25
Moxifloxacin (CB)	10 000	0.1N NaOH ¹	DW	84.0	1.0
Ethionamide	10 000	DMSO	DMSO	420.0	5.0
Amikacin	10 000	DW	DW	84.0	1.0
Linezolid	1 000	DW	DW	84.0	1.0
Bedaquiline	1 000	DMSO	DMSO	84.0	1.0
Delamanid	10 000	DMSO	DMSO	5.04	0.06
Clofazimine	10 000	DMSO	DMSO	84.0 ²	1.0

DW = Sterile distilled water; DMSO = dimethyl-sulfoxide; NaOH = Sodium-hydroxide.

¹ NaOH is added drop by drop until complete dissolution of the compound, thereafter DW is added up to the total volume.

² Clofazimine working solution must be prepared new before use starting from the stock solution (10 000 mg/L) as this drug is unstable at low concentration.

Concentrated solution in the appropriate diluent can be stored at -20°C for up to 6 months. Stability of the concentrated solution varies for the different drugs. Working solutions are usually unstable and should be prepared fresh before use.

Inoculation

The inoculum for indirect drug susceptibility testing in Bactec MGIT can be prepared from liquid or solid media, according to the manufacturer's guidelines [48]. Testing using inoculum from liquid media includes the following steps:

- A positive MGIT culture tube is used as the inoculum. The tube is inverted one to two times and then left undisturbed for about five to ten minutes to let big clumps settle to the bottom;
- The inoculum (supernatant) of the positive MGIT tube is used undiluted within 1-3 days after positivity has been flagged by the Bactec MGIT instrument for culture positivity, or diluted 1:5 if incubated 4-5 days after. A volume of 0.5 ml of the suspension has to be added aseptically into every drug-containing tube;
- For each set of AST, the control tube will be 1:100 dilution of the original inoculum (1% control): the inoculum is diluted 1:100 by adding 0.1 ml of the suspension to 10 ml of sterile saline. The tube has to be well mixed before adding 0.5 ml into the growth-control tube. For pyrazinamide testing performed in MGIT culture media with reduced pH that is provided by the manufacturer Becton Dickinson a 1:10 diluted growth control is used.

Incubation

After inoculation, the tubes are incubated at 37 °C in the Bactec MGIT instrument where fluorescence is detected automatically. In manual operation, tubes are incubated at 37 °C and are read under UV light every day.

7.4.4 Report interpretation

The BACTEC MGIT 960 instrument continually monitors all tubes for increased fluorescence. Fluorescence in the drug-containing tubes is compared to the fluorescence in the Growth Control (GC) tube to determine the susceptibility results. When the growth unit (GU) of the GC (i.e. 1% inoculum and 10% for PZA) reaches a predetermined threshold (i.e. 400 GU) within 4-13 days (SIRE) or 4-21 days (PZA), the GU values of the drug containing vials are evaluated.

³ NIH AIDS Reagent Program: www.hivreagentprogram.org/Catalog/HRPantimicrobialCompoundsandOtherChemicals/ARP-12702.aspx

⁴ BEI resources: www.beiresources.org/Catalog/BEIantimicrobialCompoundsandOtherChemicals/NR-51636.aspx

Results are qualitative: if the GU of drug containing tube is less than 100, the strain is reported susceptible. Conversely, if the GU of the drug containing tube is more than 100, the strain is reported as resistant. If the GC is still negative after 14 days, the test should be repeated paying attention to the inoculum preparation procedure and considering the strain growth capacity (dysgony).

The MGIT 960 System coupled with the TB eXiST module (eXtended individual Susceptibility Testing) running on a separate computer equipped with the EpiCenter software can be used to perform AST for a panel of second line drugs for which critical concentrations have been established for this method [49]. The module also allows extending the protocol length beyond 13 days in order to accommodate slow-growing resistant MTBC isolates.

All positive tubes should be checked for contamination, by preparing a Gram-stained smear and/or adding one drop onto a blood plate, and for mycobacterial growth by preparing a Ziehl-Neelsen stained smear.

7.5 Minimum Inhibitory Concentration (MIC) determination following the EUCAST reference method

Although several methods have been described for the determination of minimal inhibitory concentrations (MIC) of antituberculous agents against MTBC isolates, no standardised methods were available before 2019 to enable measuring the epidemiologic cut off values (ECOFFs) and clinical breakpoints according to EUCAST strategies. In 2016, the EUCAST subcommittee for anti-mycobacterial drug susceptibility testing (AMST) was launched with a primary goal of defining a reference method for MIC determination of the MTBC. This reference method has been made publicly available on the EUCAST website in July 2019 (https://www.eucast.org/mycobacteria/methods_in_mycobacteria) with a protocol published in 2020 [34] along with preliminary results [50]. The main criteria of the protocol agreement was to produce MIC results with good reproducibility.

Briefly, the protocol is a broth microdilution method in Middlebrook 7H9-10% OADC medium. The final inoculum is a 105 CFU/mL suspension, obtained from a 10⁻² dilution of a 0.5 McFarland suspension prepared after vortexing bacterial colonies with glass beads before making a suspension in sterile water. The culture is maintained in a U-shaped 96-well polystyrene microtitre sterile plate with a lid incubated at 36 ± 1 °C (an example of plate configuration is shown in Figure 13). Reading is done using an inverted mirror. The MIC, expressed in mg/L, is the lowest concentration that inhibits visual growth, as soon as the 1:100 diluted control (i.e. 103 CFU/mL suspension) shows visual growth.

EUCAST-AMST used *Mycobacterium tuberculosis* H37Rv ATCC 27294 as a reference strain and its targeted MIC values were within the range 0.03-0.12 for isoniazid, 0.12-0.5 for levofloxacin and 0.25-1 mg/L for amikacin [50].

All drug solutions should be prepared according with the Good Manufacturing Practice (GMP) and powders must be obtained directly from the drug manufacturer or from reliable commercial sources together with appropriate documentation for quality assurance. Generally, drugs should be dissolved as described in ISO-20776-1 guidelines or if not listed, per recommendation of the manufacturer.

Since many antituberculous drugs are not soluble in water, the solvent should be used with caution with regard to its own potential inhibitory effect against MTBC. Consequently, for solvents other than water, such as DMSO, there should be growth controls containing the same proportion of solvent (e.g. in case of DMSO) as the drug containing medium, and the concentration of the solvent should be the same for all concentrations. For example, bedaquiline, delamanid, pretomanid, clofazimine are dissolved in DMSO and the final concentration in each well could be 1% or 0.5% DMSO, according to the manufacturer's recommendation. Due to limited solubility of these drugs, serial dilution of the drug should be made first with 100% DMSO before addition (1/100) to each well.

Figure 13. Scheme of the microtitre plate for the EUCAST AMST broth microdilution reference protocol

	1	2	3	4	5	6	7	8	9	10	11	12
A	200ul dH20	200ul dH20	200ul dH20	200ul dH20	200ul dH20	200ul dH20	200ul dH20	200ul dH20	200ul dH20	200ul dH20	200ul dH20	200ul dH20
B	negative control	GC 100%	AA1 (10-2) C8	AA1 (10-2) C7	AA1 (10-2) C6	AA1 (10-2) C5	AA1 (10-2) C4	AA1 (10-2) C3	AA1 (10-2) C2	AA1 (10-2) C1	GC 1%	200ul dH20
C	negative control	GC 100%	AA1 (10-2) C8	AA1 (10-2) C7	AA1 (10-2) C6	AA1 (10-2) C5	AA1 (10-2) C4	AA1 (10-2) C3	AA1 (10-2) C2	AA1 (10-2) C1	GC 1%	200ul dH20
D	negative control	GC 100%	AA2 (10-2) C8	AA2 (10-2) C7	AA2 (10-2) C6	AA2 (10-2) C5	AA2 (10-2) C4	AA2 (10-2) C3	AA2 (10-2) C2	AA2 (10-2) C1	GC 1%	200ul dH20
E	negative control	GC 1%	AA2 (10-2) C8	AA2 (10-2) C7	AA2 (10-2) C6	AA2 (10-2) C5	AA2 (10-2) C4	AA2 (10-2) C3	AA2 (10-2) C2	AA2 (10-2) C1	GC 100%	200ul dH20
F	negative control	GC 1%	AA3 (10-2) C8	AA3 (10-2) C7	AA3 (10-2) C6	AA3 (10-2) C5	AA3 (10-2) C4	AA3 (10-2) C3	AA3 (10-2) C2	AA3 (10-2) C1	GC 100%	200ul dH20
G	negative control	GC 1%	AA3 (10-2) C8	AA3 (10-2) C7	AA3 (10-2) C6	AA3 (10-2) C5	AA3 (10-2) C4	AA3 (10-2) C3	AA3 (10-2) C2	AA3 (10-2) C1	GC 100%	200ul dH20
H	200ul dH20	200ul dH20	200ul dH20	200ul dH20	200ul dH20	200ul dH20	200ul dH20	200ul dH20	200ul dH20	200ul dH20	200ul dH20	200ul dH20

AA1 – AA3 Antituberculous agent 1-3; GC, growth control; GC 100% corresponds to the same inoculum as in the drug containing wells; GC 1% corresponds to the hundredfold diluted inoculum; negative control is 200 µL of 7H9-OADC; dH20, sterile distilled water.

References

1. Drobniewski F, Rüscher-Gerdes S, Hoffner S; Subcommittee on Antimicrobial Susceptibility Testing of *Mycobacterium tuberculosis* of the European Committee for Antimicrobial Susceptibility Testing (EUCAST) of the European Society of Clinical Microbiology and Infectious Diseases (ESCMID). Antimicrobial susceptibility testing of *Mycobacterium tuberculosis* (EUCAST document E.DEF 8.1)--report of the Subcommittee on Antimicrobial Susceptibility Testing of *Mycobacterium tuberculosis* of the European Committee for Antimicrobial Susceptibility Testing (EUCAST) of the European Society of Clinical Microbiology and Infectious Diseases (ESCMID). Clin Microbiol Infect. 2007 Dec;13(12):1144-56. doi: 10.1111/j.1469-0691.2007.01813.x. Epub 2007 Aug 29. PMID: 17727670.
2. Schön T, Miotto P, Köser CU, Viveiros M, Böttger E, Cambau E. *Mycobacterium tuberculosis* drug-resistance testing: challenges, recent developments and perspectives. Clin Microbiol Infect. 2017 Mar;23(3):154-60.
3. World Health Organization (WHO). Implementing the end TB strategy: the essentials. WHO/HTM/TB/2015.31.
4. World Health Organization (WHO). WHO consolidated guidelines on tuberculosis. Module 4: treatment - drug-susceptible tuberculosis treatment. Geneva: WHO; 2022. Licence: CC BY-NC-SA 3.0 IGO.
5. World Health Organization (WHO). WHO operational handbook on tuberculosis Module 4: Treatment – drug-susceptible tuberculosis treatment. Geneva: WHO; 2022. Licence: CC BY-NC-SA 3.0 IGO.
6. Zignol M, Dean AS, Falzon D, van Gemert W, Wright A, van Deun A, et al. Twenty Years of Global Surveillance of Antituberculosis-Drug Resistance. N Engl J Med. 2016 Sep 15;375(11):1081-9.
7. Mitchison DA. The diagnosis and therapy of tuberculosis during the past 100 years. Am J Respir Crit Care Med. 2005 Apr 01;171(7):699-706.
8. Böttger EC. The ins and outs of *Mycobacterium tuberculosis* drug susceptibility testing. Clin Microbiol Infect. 2011 Aug;17(8):1128-34.
9. Zhang S, Chen J, Shi W, Liu W, Zhang W, Zhang Y. Mutations in panD encoding aspartate decarboxylase are associated with pyrazinamide resistance in *Mycobacterium tuberculosis*. Emerg Microbes Infect. 2013 Jun;2(6):e34.
10. Bateson A, Ortiz Canseco J, McHugh TD, Witney AA, Feuerriegel S, Merker M, et al. Ancient and recent differences in the intrinsic susceptibility of *Mycobacterium tuberculosis* complex to pretomanid. J Antimicrob Chemother. 2022 05 29;77(6):1685-93.
11. World Health Organization (WHO). Technical manual for drug susceptibility testing of medicines used in the treatment of tuberculosis. WHO. License: CC BY-NC-SA 3.0 IGO. Available at: <https://apps.who.int/iris/handle/10665/275469>
12. World Health Organization (WHO). Technical report on critical concentrations for drug susceptibility testing of medicines used in the treatment of drug-resistant tuberculosis. WHO. License: CC BY-NC-SA 3.0 IGO. Available at: <https://apps.who.int/iris/handle/10665/260470>
13. World Health Organization (WHO). Technical report on critical concentrations for drug susceptibility testing of isoniazid and the rifamycins (rifampicin, rifabutin and rifapentine). WHO; 2021. Licence: CC BY-NC-SA 3.0 IGO.
14. Hillemann D, Hoffner S, Cirillo D, Drobniewski F, Richter E, Rüscher-Gerdes S, et al. First evaluation after implementation of a quality control system for the second line drug susceptibility testing of *Mycobacterium tuberculosis* joint efforts in low and high incidence countries. PLoS One. 2013;8(10):e76765.
15. Bwanga F, Hoffner S, Haile M, Joloba ML. Direct susceptibility testing for multi drug resistant tuberculosis: a meta-analysis. BMC Infect Dis. 2009 May 20;9:67.
16. World Health Organization (WHO). 2012. Tuberculosis laboratory biosafety manual. Available at: http://apps.who.int/iris/bitstream/10665/77949/1/9789241504638_eng.pdf?ua=1
17. EUCAST. MIC distributions and the setting of epidemiological cutoff (ECOFF) values. 2019. Available at: http://www.eucast.org/fileadmin/src/media/PDFs/EUCAST_files/EUCAST_SOPs/EUCAST_SOP_10.1_MIC_distributions_and_epidemiological_cutoff_value_ECOFF_setting_20191130.pdf
18. Canetti G. Present aspects of bacterial resistance in tuberculosis. Am Rev Respir Dis. 1965 Nov;92(5):687-703.
19. Mitchison DA. Drug resistance in tuberculosis. Eur Respir J. 2005 Feb;25(2):376-9.
20. Werngren J, Sturegård E, Juréen P, Ängeby K, Hoffner S, Schön T. Reevaluation of the critical concentration for drug susceptibility testing of *Mycobacterium tuberculosis* against pyrazinamide using wild-type MIC distributions and pncA gene sequencing. Antimicrob Agents Chemother. 2012 Mar;56(3):1253-7.
21. Ängeby K, Juréen P, Kahlmeter G, Hoffner SE, Schön T. Challenging a dogma: antimicrobial susceptibility

- testing breakpoints for *Mycobacterium tuberculosis*. Bull World Health Organ. 2012 Sep 01;90(9):693-8.
22. Clinical and Laboratory Standards Institute, Laboratory detection and identification of mycobacteria; approved guideline. 2008. CLSI, M48-A. Wayne, PA.
 23. World Health Organization (WHO). Treatment of drug-susceptible tuberculosis: rapid communication. June 2021.
 24. World Health Organization (WHO). WHO consolidated guidelines on tuberculosis. Module 4: treatment - drug-resistant tuberculosis treatment. Online annexes. 2020.
 25. World Health Organization (WHO). Rapid communication: key changes to the treatment of drug-resistant tuberculosis. Geneva: 2022 (WHO/UCN/TB/2022.2). Licence: CC BY-NC-SA 3.0 IGO.
 26. Dovprela. Summary of product characteristics (last update July 2022). Available at: https://www.ema.europa.eu/en/documents/product-information/dovprela-epar-product-information_en.pdf
 27. Heifets L. Qualitative and quantitative drug-susceptibility tests in mycobacteriology. Am Rev Respir Dis. 1988 May;137(5):1217-22.
 28. Canetti G, Fox W, Khomenko A, Mahler HT, Menon NK, Mitchison DA, et al. Advances in techniques of testing mycobacterial drug sensitivity, and the use of sensitivity tests in tuberculosis control programmes. Bull World Health Organ. 1969;41(1):21-43.
 29. Bergmann JS, Woods GL. Mycobacterial growth indicator tube for susceptibility testing of *Mycobacterium tuberculosis* to isoniazid and rifampin. Diagn Microbiol Infect Dis. 1997 Jul;28(3):153-6.
 30. Rüschi-Gerdes S, Domehl C, Nardi G, Gismondo MR, Welscher HM, Pfyffer GE. Multicenter evaluation of the mycobacteria growth indicator tube for testing susceptibility of *Mycobacterium tuberculosis* to first-line drugs. J Clin Microbiol. 1999 Jan;37(1):45-8.
 31. Bemer P, Palicova F, Rüschi-Gerdes S, Drugeon HB, Pfyffer GE. Multicenter evaluation of fully automated BACTEC Mycobacteria Growth Indicator Tube 960 system for susceptibility testing of *Mycobacterium tuberculosis*. J Clin Microbiol. 2002 Jan;40(1):150-4.
 32. Kruuner A, Yates MD, Drobniewski FA. Evaluation of MGIT 960-based antimicrobial testing and determination of critical concentrations of first- and second-line antimicrobial drugs with drug-resistant clinical strains of *Mycobacterium tuberculosis*. J Clin Microbiol. 2006 Mar;44(3):811-8.
 33. Schön T, Köser CU, Werngren J, Viveiros M, Georghiou S, Kahlmeter G, et al. What is the role of the EUCAST reference method for MIC testing of the *Mycobacterium tuberculosis* complex? Clin Microbiol Infect. 2020 Nov;26(11):1453-55.
 34. Schön T, Werngren J, Machado D, Borroni E, Wijkander M, Lina G, et al. Antimicrobial susceptibility testing of *Mycobacterium tuberculosis* complex isolates - the EUCAST broth microdilution reference method for MIC determination. Clin Microbiol Infect. 2020 Nov;26(11):1488-92.
 35. Canetti G, Froman S, Grosset J, Hauduroy P, Langerova M, Mahler HT, et al. Mycobacteria: Laboratory Methods for Testing Drug Sensitivity and Resistance. Bull World Health Organ. 1963;29:565-78.
 36. World Health Organization. Noncommercial culture and drug-susceptibility testing methods for screening patients at risk for multidrug-resistant tuberculosis: policy statement. WHO/HTM/TB/2011.9. WHO, Geneva 2011.
 37. Moore DA, Evans CA, Gilman RH, Caviedes L, Coronel J, Vivar A, et al. Microscopic-observation drug-susceptibility assay for the diagnosis of TB. N Engl J Med. 2006 Oct 12;355(15):1539-50.
 38. Toit K, Mitchell S, Balabanova Y, Evans CA, Kummik T, Nikolayevskyy V, et al. The Colour Test for drug susceptibility testing of *Mycobacterium tuberculosis* strains. Int J Tuberc Lung Dis. 2012 Aug;16(8):1113-8.
 39. Fitzwater SP, Sechler GA, Jave O, Coronel J, Mendoza A, Gilman RH, et al. Second-line anti-tuberculosis drug concentrations for susceptibility testing in the MODS assay. Eur Respir J. 2013 May;41(5):1163-71.
 40. Coban AY, Deveci A, Sunter AT, Martin A. Nitrate reductase assay for rapid detection of isoniazid, rifampin, ethambutol, and streptomycin resistance in *Mycobacterium tuberculosis*: a systematic review and meta-analysis. J Clin Microbiol. 2014 Jan;52(1):15-9.
 41. Coban AY, Deveci A, Sunter AT, Palomino JC, Martin A. Resazurin microtiter assay for isoniazid, rifampicin, ethambutol and streptomycin resistance detection in *Mycobacterium tuberculosis*: Updated meta-analysis. Int J Mycobacteriol. 2014 Dec;3(4):230-41.
 42. Lee J, Armstrong DT, Ssengooba W, Park JA, Yu Y, Mumbowa F, et al. Sensititre MYCOTB MIC plate for testing *Mycobacterium tuberculosis* susceptibility to first- and second-line drugs. Antimicrob Agents Chemother. 2014;58(1):11-8.
 43. Kontsevaya I, Werngren J, Holicka Y, Klaos K, Tran A, Nikolayevskyy V. Non-commercial phenotypic assays for the detection of *Mycobacterium tuberculosis* drug resistance: a systematic review. Eur J Clin Microbiol Infect Dis. 2020 Mar;39(3):415-26.

44. Cambau E, Viveiros M, Machado D, Raskine L, Ritter C, Tortoli E, et al. Revisiting susceptibility testing in MDR-TB by a standardized quantitative phenotypic assessment in a European multicentre study. *J Antimicrob Chemother.* 2015 Mar;70(3):686-96.
45. World Health Organization (WHO). WHO operational handbook on tuberculosis. Module 4: treatment - drug-resistant tuberculosis treatment. 2020.
46. Pfyffer GE, Bonato DA, Ebrahimzadeh A, Gross W, Hotaling J, Kornblum J, et al. Multicenter laboratory validation of susceptibility testing of *Mycobacterium tuberculosis* against classical second-line and newer antimicrobial drugs by using the radiometric BACTEC 460 technique and the proportion method with solid media. *J Clin Microbiol.* 1999 Oct;37(10):3179-86.
47. Pfyffer GE, Palicova F, Rüscher-Gerdes S. Testing of susceptibility of *Mycobacterium tuberculosis* to pyrazinamide with the nonradiometric BACTEC MGIT 960 system. *J Clin Microbiol.* 2002 May;40(5):1670-4.
48. Global Laboratory Initiative. Mycobacteriology Laboratory Manual. 2014.
49. Springer B, Lucke K, Calligaris-Maibach R, Ritter C, Böttger EC. Quantitative drug susceptibility testing of *Mycobacterium tuberculosis* by use of MGIT 960 and EpiCenter instrumentation. *J Clin Microbiol.* 2009 Jun;47(6):1773-80.
50. Schön T, Werngren J, Machado D, Borroni E, Wijkander M, Lina G, et al. Multicentre testing of the EUCAST broth microdilution reference method for MIC determination on *Mycobacterium tuberculosis*. *Clin Microbiol Infect.* 2021 Feb;27(2):288.e1-88.e4.

8 Molecular typing of *Mycobacterium tuberculosis* complex isolates

Girts Skenders, Dick van Soolingen

Revised by Stefan Niemann and Vladyslav Nikolayevskyy (2015)

Revised by Thomas A. Kohl, Andrea M. Cabibbe (2022)

8.1 Background and principles

In the last two decades, multiple molecular typing methods for *Mycobacterium tuberculosis* complex (MTBC) isolates have emerged, with different levels of reproducibility, discriminative power and demands on technical expertise.

Previously, phage typing, anti-TB drugs susceptibility profiling and other biochemical features allowed the differentiation of only a very limited number of strains, while nowadays, DNA-based typing techniques can potentially discriminate even individual transmission events. At present, DNA fingerprinting supports routine contact tracing in many countries as well as studies on person-to-person transmission, early disease outbreak identification, high transmission risk groups, laboratory cross-contamination [1, 2] and the distinction between reinfection and reactivation [3, 4]. In particular DNA fingerprinting of *M. tuberculosis* has greatly improved the understanding of TB transmission, which is especially important for drug-resistant strains. Moreover, the recognition of genotype families has facilitated studies on the population structure of MTBC and its transmission dynamics.

The various DNA fingerprinting methods available serve different purposes and have variable characteristics that enable their use in specific applications. Legacy typing approaches interrogate defined and highly variable targets in the genome, and include methods such as spoligotyping, MIRU-VNTR (Mycobacterial Interspersed Repetitive Units – Variable Number of Tandem Repeats) typing and IS6110 RFLP (Restriction Fragment Length Polymorphism). The advent of whole genome sequencing (WGS) based on next generation sequencing (NGS) technology allows genome-based typing thus offering the highest possible discrimination and resolution power for molecular epidemiology of MTBC. Conversely, a targeted NGS approach interrogates small portions of the genome, but it can nevertheless yield phylogenetic classification, spoligotype data, and resistance profile prediction from primary patient samples. This chapter aims to describe the characteristics of these methods and their most important applications.

Although the application of DNA fingerprinting has improved our knowledge of the natural history of TB infections and the disease dynamics, there are still open questions. All DNA fingerprinting methods operate according to different molecular clocks⁵ and the stability of DNA profiles has been studied extensively, but is not fully understood [5]. Ideally, from the perspective of molecular typing, every transmission results in a slight change in the DNA fingerprint, while the strains remain recognisable, which makes it possible to distinguish primary sources in a chain of transmission from secondary and tertiary ones, enabling much more detailed analysis of transmission in a given area. Unfortunately, mutations in the genome of MTBC occur according to a stochastic process and therefore DNA fingerprinting will never be a perfect tool in studies on transmission. However, the application of e.g. WGS of *M. tuberculosis* isolates for the visualisation of transmission chains has demonstrated the discriminatory power of this approach. In addition, genome data have successfully been used to infer evolutionary dynamics especially towards resistance, and it may even help to unravel epidemiological linkages across time and space.

Below is an outline of the three traditional DNA fingerprinting methods: spoligotyping, MIRU-VNTR typing and RFLP typing, followed by a description of WGS and targeted NGS.

8.2 IS6110 RFLP typing

The restriction fragment length polymorphism (RFLP) method for typing bacterial strains was the first DNA-strain typing method that proved to be suitable for studying transmission [6]. It is based on the fact that the number of IS6110 mobile insertion sequences of 1.35kb present in the genome of strains differs from 0 to approximately 30. These genomic insertion sites themselves are also highly variable in MTBC strains, resulting in highly variable banding patterns.

The generation of RFLP patterns is technically demanding and time consuming, and requires a high amount (i.e. 2 µg) of purified genomic DNA as starting material. The process involves restriction enzyme cleavage of the DNA; fragment

⁵ A measure of evolutionary change over time at the molecular level that is based on the theory that specific DNA sequences spontaneously mutate at constant rates. This measure is chiefly used for estimating how long ago two related organisms diverged from a common ancestor.

separation by electrophoresis; the transfer of the fragments to a DNA membrane and hybridization with a DNA labelled probe complementary to the *IS6110* transposon sequence, and final visualisation of the results on a light-sensitive film. Each individual step of the process is crucial for the final result, which also gives an idea of the difficulties experienced with regard to inter-laboratory comparability.

In addition, the analysis of *IS6110* RFLP patterns with the specialised software like BioNumerics is complex, requiring experienced users. However, the difficulties associated with RFLP typing have not altered the fact that RFLP typing has revolutionised our understanding of TB transmission. Moreover, for strains of particular genotype families such as the Beijing clade, the level of discrimination of RFLP typing is still superior to that of the more recently introduced 24-loci MIRU-VNTR typing [7-9].

8.3 Spoligotyping

Spoligotyping is based on polymorphisms in the direct repeat (DR) locus of the mycobacterial chromosome [10, 11]. The well-conserved 36-bp direct repeats are interspersed with unique spacer sequences, varying from 35 to 41 bp in size. The order of the spacers has been found to be well conserved [12]. Currently, 94 different spacer sequences have been identified, 43 of which are used in the first-generation spoligotyping for *M. tuberculosis* complex strains [13]. After amplification, the denatured PCR products are applied in the reversed line on a membrane with covalently bound multiple synthetic spacer oligonucleotides deduced from DR region sequences of the two control strains (*M. tuberculosis* H37Rv and *M. bovis* BCG P3).

Clinical MTBC isolates can be differentiated by the presence or absence of one or more spacers. Almost all strains reveal a few of these spacers. The obtained patterns – 43 spacers present or not – are usually characteristic of a particular genotype family [14]. Spoligotyping is therefore a simple, cheap, rapid and reproducible [15] tool to study the phylogeny of MTBC strains or to associate phenotypic features of isolates with the genotype family the bacteria represent [11]. The level of discrimination of spoligotyping is generally low and it is necessary to be cautious when using this method to examine the TB transmission at the strain level [16, 8]. However, it is possible to use spoligotyping as a screening method in typing to rule out transmission when different spoligotyping profiles are obtained. On the other hand, when spoligotype patterns are identical, then no conclusion can be drawn regarding the epidemiological relationship between the respective patients. The SpolDB4 database is one of the largest publicly available databases on MTBC and contains spoligotype patterns from approximately 40 000 clinical isolates representing 122 countries.

8.4 MIRU-VNTR typing

The mycobacterial interspersed repetitive unit variable number tandem repeats (MIRU-VNTRs) assessment of bacterial strains has proven to be a suitable method for the detection of genetic polymorphisms within bacterial species [17]. Differences in the number of tandem repeats in the 24 stretches of the genome of MTBC strains are the basis for this internationally recognised typing method. In multiplex PCRs, up to 24 loci are amplified using primers specific for the flanking regions of each repeat locus, after which the size of the amplified stretches of tandem repeats are used to determine the number of tandem repeats present. The number of tandem repeats detected at the different loci results in a numerical code that serves as a DNA fingerprint of the respective TB bacteria and allows users to easily exchange the MIRU-VNTR typing results and perform inter-laboratory comparisons.

The determination of the PCR products in MIRU-VNTR typing can be done manually by performing all single-locus PCRs, and then interpreting the product length using electrophoreses. However, nowadays, MIRU-VNTR typing kits containing all the reagents necessary to perform MIRU typing on 24 VNTR loci, in accordance with the international standard are also commercially available (e.g. GenoScreen, Lille; France) and automated and higher throughput methods are widely available, which allow to determine the size of the PCR products by sequencing using dye labelled primers, thus saving time and increasing accuracy.

The 24 loci MIRU-VNTR typing allows to distinguish unrelated strains and provides the clonal stability to reliably identify isolates from the same transmission chain [18].

Open databases where users can add MIRU-VNTR patterns for the online analysis of the clonal identification of MTBC isolates are widely available (e.g. MIRU-VNTR*plus* database) [19]. Cluster analysis can also be done locally using the BioNumerics software (Applied Maths, Ghent, Belgium). National molecular epidemiology databases with embedded cluster analysis tools exist in several EU countries. Cluster analysis tools are also available within international databases and epidemiology reporting tools, e.g. TESSY.

Detailed protocols on multilocus MIRU-VNTR typing are available at: <https://www.miru-vntrplus.org/MIRU/files/MIRU-VNTRtypingmanualv6.pdf>

8.5 Whole genome sequencing

Although classic genotyping methods target highly variable genetic elements, they only interrogate a small fraction of the genome. Therefore, they cannot capture microevolution potentially occurring in other genomic regions. In contrast, WGS based on NGS gives access to nearly complete genome sequences. The extended use of such approach for research and epidemiological control has become possible through the rapid improvements and increasing affordability of NGS technologies. So-called 'benchtop' NGS systems generating sequencing data in the range of 10-20 Gb can be integrated into a routine workflow, with a throughput adapted to a routine microbiological laboratory [20, 21]. In addition, commercially available easy-to-use kits for DNA library preparation and sample multiplexing require only small amounts of genomic DNA inputs, which shortens the time needed to get enough material for DNA extraction from culture of slow-growing mycobacteria.

The overall workflow for WGS starts from purified genomic DNA extracted from bacterial culture. This is converted to a set ('library') of fragments of a defined size with specific adapter sequences at both ends of the fragment. Libraries are loaded onto NGS instruments resulting in millions of short sequence reads per sample. Using a dedicated bioinformatics pipeline, this data can be used to detect genomic mutations compared to a reference genome (usually that of *M. tuberculosis* H37Rv). For genotyping and similarity/relatedness analysis, the respective set of single nucleotide polymorphism (SNP) variants is often used. An interesting alternative from WGS data is the core genome multi locus sequence typing (cgMLST) approach, which offers inherent standardization and easy incorporation of new datasets into a comparison enabling ongoing real-time surveillance [22]. Implementation of a suitable analysis pipeline should follow accepted standards and include evaluation against reference datasets of established analysis solutions [23, 24].

Interestingly, due to the nature of NGS technology and its limitations, it is possible to extract spoligotype patterns from whole genome sequencing data, whereas MIRU-VNTR and IS6110 fingerprinting types cannot be reliably inferred from NGS data.

Several studies demonstrated that whole genome-based approaches provide more resolution than classical genotyping (e.g. 24-loci MIRU-VNTR typing and IS6110 fingerprinting)[25-28, 21]. In particular, whole genome sequence analysis allows for a more precise differentiation of isolates belonging to a specific recent transmission chain from other, closely but not directly related isolates, which is especially useful in resolving complex outbreak situations [27, 28, 21]. In such situations, the phylogenetic trees based on the obtained genome-wide SNP or cgMLST data of the isolates correlate much better with the available epidemiological data, and the spatio-temporal distribution patterns of the corresponding TB cases, than trees based on classic typing data [28, 21, 29-31]. In addition to a better time-dependent signal, the higher resolution offered by whole genome-based analysis also provides other valuable information. For example, the presence of a particularly contagious case (i.e. a super-spreader), leading to multiple secondary cases, can be inferred by the observation of star-like topologies in the phylogenetic tree, where clonal variants only differing by a few SNPs or alleles and corresponding to secondary cases branch directly from a central node, representing the same single source case.

Furthermore, the identification of vacant nodes in the tree topology is suggestive of undiagnosed cases in the population. The unidirectional accumulation of SNPs allows a more clear-cut association of new cases with previous cases in a longitudinal outbreak, which may allow for more targeted contact tracing investigations [28, 21]. This can be of use for the precise determination of the source cases for patient isolates of particular importance, such as MDR isolates.

To identify and delineate recent transmission chains based on whole genome sequences, a key parameter to calibrate is the level of genome-wide variation that occurs in *M. tuberculosis* strains within and between infected individuals over time. In different studies, the observed levels of divergence between such longitudinal isolates collected from chronically-infected patients or from epidemiologically-linked cases rarely exceeded three to five SNPs, thus defining a cut-off range for predicting recent transmission [26, 28, 21]. The calculated mean rate of change in DNA sequence was approximately 0.5 SNPs per genome per year, providing a quantitative estimate of the short-term evolution rate of *M. tuberculosis* in the human host population [28, 21]. Interestingly, this rate matches the mutation rate estimated for *M. tuberculosis* in a macaque infection model [32]. Given sufficient data, a dedicated analysis pipeline can unravel outbreak dynamics and estimate the temporal and spatial distribution and evolutionary history of a phylogenetic clade [33-37].

Compared to classic genotyping, another major advantage of whole genome sequencing is that it simultaneously provides direct and valuable information for predicting drug resistance, as well as highest resolution genotyping [38, 20]. This combination of diagnostic and epidemiological information in a single assay is a great benefit, especially with *M. tuberculosis* for which early detection of drug resistance is important. Analysis based on whole genome sequencing goes far beyond conventional molecular tests, focusing on known selected mutations in hotspot regions of genes involved in resistance to first and second-line anti-tuberculous drugs, thereby possibly missing novel resistance-associated mutations [39]. In principle, WGS captures most, if not all the gene sequences determining the so-called *M. tuberculosis* resistome, which allows interrogation of all known mutations associated with drug resistance [20]. Moreover, whole genome sequencing at high coverage may detect the emergence and

co-existence of different drug resistance- conferring mutations before selection and fixation of a final mutant, in possible combination with compensatory mutations [40, 41]. Such detection is of clinical relevance as the co-existence of wild-type and mutant subpopulations resulting in hetero-resistance may confound the current phenotypic and molecular drug resistance tests [40, 41] as well as conclusions on transmission or secondary acquisition of drug resistance. In general, the inference of a resistance profile from whole genome data relies on well curated databases capturing resistance-associated mutations and ideally also variants not linked to resistance. Interpretation of the molecular variants leading to resistance to bedaquiline and delamanid is more complex and requires the evaluation of a large number of resistant strains to reach the same confidence we have for rifampicin. Recent initiatives led by the ReSeqTB and CRyPTIC consortium together with WHO led to the implementation of curated and up-to-date resources for resistance-associated genetic markers [42-45].

8.6 Targeted NGS

In addition to whole genome characterisation, next generation sequencing can also be used together with a specific enrichment or amplification protocol to enable complex primary patient samples as input and vastly increased sensitivity. The option to work directly with patient samples reduces turn-around times and still reaching similar levels of sensitivity compared with classical genotyping and molecular resistance detection methods [46, 47]. Of course, the restriction to a defined set of genomic regions will not allow the same level of resolution power as WGS. Still, general classification such as mycobacterial species identification, lineage determination, and spoligotyping are possible given respective genomic regions are targeted (e.g. Deeplex MycTB, Genoscreen). This approach enables at least to rule out transmission chains when different spoligotypes and phylogenetic SNPs are detected among strains and may be suggestive of certain relatedness when same phylogenetic SNPs / spoligotypes (and DR patterns) are identified among samples epidemiologically linked or for clonal strains circulating in restricted settings. While commercially available targeted NGS solutions can be employed directly on DNA extracted from patient samples, the sensitivity threshold is currently still not well defined, but microscopy positive samples can commonly be analysed successfully.

8.7 General considerations on genotyping methods

The five DNA genotyping methods here described can be used for different applications. Spoligotyping is generally used in studies to reveal the genotype family of the respective bacteria; whereas this technique is less suitable for strain typing. Both RFLP and 24-loci-MIRU-VNTR typing have a higher level of discrimination and reproducibility and can be used for strain typing. The turn-around time of MIRU-VNTR typing is significantly shorter than that of RFLP typing and it is also technically far less demanding. In addition, MIRU-VNTR typing can be used in contact tracing and source-case finding and can reliably rule out transmission.

WGS has become available with the introduction of NGS, and the respective technology is still quickly evolving. Notably, WGS offers the highest possible resolution for outbreak analysis and tracing transmission chains. The compilation of extensive data about resistance-associated genomic variants also offers the possibility to infer a comprehensive resistance profile from both whole genome and targeted NGS data.

Although NGS-based molecular tracing of MTBC has a vast potential, its generalised use is still hampered by some remaining challenges. Despite rapid cost decreases, NGS analyses still remain too costly for many TB laboratories, especially since the implementation of NGS analysis carries high initial investment costs. For most NGS approaches, costs are also directly affected by the batch size and multiplexing, as performing incomplete sequencing runs significantly increases the cost per sample. Another important factor relates to the integration of NGS into existing laboratory workflows. It has been shown that when including resistance analysis, WGS can actually be cost-competitive with standard approaches and an interesting option also for low-middle income settings [48, 49].

In addition to the technical training and specialised skills required for performing the 'wet' component of the NGS workflow, the need for expert guidance on sequencing data analysis and interpretation should also be considered. Moreover, the 'dry' component of the NGS workflow requires a dedicated IT infrastructure for data management and data storage. In contrast to classic genotyping, technical and analytical modalities (e.g. the precise delimitation of the genome sequence that is taken into account in the analysis; the minimal sequence coverage; etc.) have not yet been standardised [24]. Consequently, datasets generated by different laboratories are not yet directly comparable, and universal databases are not yet available (e.g., for multicentric longitudinal epidemiological studies and surveillance.). While WHO recently published a comprehensive catalogue of resistance-associated mutations together with the CRyPTIC consortium [45] the underlying bioinformatics functionality for the detection of resistance-conferring variants is not yet standardised [24].

As an important point, the input material required for WGS analysis of TB samples can only reliably be gained from cultures. Even modern workflows require at least 1 ng of pure DNA, and the process is relatively sensitive to contaminations as there is no specific amplification of genomic targets. This is partially overcome by targeted NGS, which

includes specific amplification of targeted genomic regions. However, targeted NGS will not allow for high resolution genotyping.

Contact tracing complemented by genotyping is considered to be important for understanding person-to-person transmission. It is less clear, however, to which extent genotyping itself is cost-effective and if it has any added value beyond contact tracing from an immediate public health point of view [50].

The performance of DNA fingerprinting has also been used for predicting the size of future clusters following the detection of the first two cases of a new cluster. Time between the cases, age, and location are variables that become known shortly after the diagnosis of a new TB cluster. By combining the molecular data and the patient's registration data, new cluster episodes can be predicted using the risk factors. This information can contribute to early warning systems for the national health services [51].

DNA fingerprinting can detect possible cross-contamination occurred in the laboratory. If a laboratory detects two isolates with identical DNA profiles in only one week, this usually indicates a sampling or laboratory mishap [1]. In this case, the clinician should be asked to review the clinical picture of the patient, and the microbiologist should check the positivity rate of the culture and whether the cultures with identical DNA fingerprints have been contaminated at a particular stage. Regular checks of positive cultures are recommended to detect this common problem; in the Netherlands, about 3% of all positive cultures are cross-contaminations [52].

The widespread application of DNA fingerprinting has provided substantial insights into TB transmission, especially when conventional epidemiological investigation and molecular typing are combined [53]. The strong association of TB transmission with gender and lower age of the source case in a low-prevalence setting has been shown by molecular fingerprinting techniques [54]. Moreover, studies on transmission within and outside households in South Africa [29,31] has yielded important insights into the origin of TB infections in a high-prevalence setting [55, 56]. There is also an increased risk that previously treated and cured TB patients will develop TB again when reinfected [57].

Recent work demonstrated the high-resolution power of WGS especially for MDR-TB outbreaks, and enabled unravelling the evolution of phylogenetic lineages towards transmissibility and resistance acquisition [58, 33, 59, 36].

8.8 Materials

Purified DNA from MTBC bacteria is generally the best material for molecular typing. For methods based on DNA amplification, such as spoligo- and MIRU-VNTR typing, only a small amount is needed as starting material. Even purified DNA from a sufficient number of bacteria in clinical material will result in a typing pattern. However, briefly incubating these bacteria in a liquid culture medium will generally yield more reliable and reproducible results, which is advisable because of the costs and the time to perform the typing techniques. For RFLP typing, based on the specific restrictions of the isolated unamplified DNA, a fully grown culture is needed as 2 µg of highly purified genomic DNA are required. In a diagnostic setting, it will take several weeks to achieve this amount of growth after TB detection.

For WGS, state-of-the-art library preparation kits require as little as 1 ng of DNA as input if using for example the Illumina sequencing platforms, but it can be significantly higher if using e.g. the MinION sequencer from Oxford Nanopore Technologies. Genomic DNA suitable for WGS can be reliably extracted from early positive liquid (MGIT) cultures [48]. Still, subculture of a positive primary specimen is a sensible step to minimise DNA contaminants from the bacterial fauna and human material. Targeted NGS can be directly employed on DNA extracted from patient samples.

Membranes, reagents and positive control DNA for spoligotyping can be purchased. The performance of spoligotyping is better, especially in laboratories with molecular experience, and the results are more comparable among different laboratories [60].

For 24-loci MIRU-VNTR typing, a kit containing all reagents for eight multiplex amplification reactions can be obtained commercially. In addition, the PCR product fragments are analysed on an automated DNA sequencer. In the absence of an expensive analyser, the 24-loci MIRU-VNTR can be used with single or multiplex amplification reactions and detection of the product, either automated or manually (see standard operating procedure on MIRU-VNTRplus website at <http://www.miru-vntrplus.org>). The quality of international MIRU-VNTR typing performance and the inter-laboratory reproducibility has significantly improved over the last years [61].

Both WGS and targeted NGS represent complex multi-step protocols requiring specific oligomers, enzymes and reagents to convert the initial DNA sample into an NGS library, and of course the sequencing instrument itself as well as a variety of auxiliary equipment. A variety of commercial solutions exist that enable the preparation of a NGS library from bacterial DNA samples. Likewise, there are various NGS instruments available, most notably also several benchtop sequencers with smaller throughput and relatively higher sequencing costs but also smaller footprint in physical dimensions and investment costs [38].

8.9 Results/interpretation

The analysis of *IS6110* RFLP patterns by BioNumerics software is technically demanding [13]. The most important aspect is the inclusion of internal (a mixture of two molecular markers) and external standards (DNA of a control strain with a suitable range of bands) for normalisation and accurate reading of the band sizes. RFLP typing consists of a lengthy, multi-step laboratory procedure that is prone to error. Poor quality in RFLP typing can be connected to laboratory technique, but very often is caused by the incorrect interpretation of results with the pattern analysis software.

Spoligotype patterns are codes of 43 possible digits and can be sorted with standard software such as Excel. However, most institutions use the BioNumerics software (Applied Maths, Kortrijk, Belgium), which is able to compare the results of any typing method. There is an international database of spoligotype patterns [13, 62] which holds tens of thousands of spoligotype patterns that can be used to compare the locally obtained typing results with patterns that have been found elsewhere and are already labelled with a genotype family designation.

The result of MIRU-VNTR typing is a numerical code of usually 12, 15, or 24 numbers which can be analysed relatively easily, as described above in the section on spoligotyping. In epidemiological investigations local comparisons are best done using the BioNumerics software for which special plugins are available. There are several international databases with MIRU-VNTR typing results in which locally obtained results can be compared with international collections (such as <http://www.miru-vntrplus.org> or http://www.pasteur-guadeloupe.fr:8081/SITVIT_ONLINE).

Due to the nature of the raw data produced by NGS instruments, any analysis requires a bioinformatics solution. This encompasses both dedicated software tools as well as suitable IT hardware for calculation and data storage. For genotyping based on whole genome data, a cgMLST approach is an interesting option with both open source and commercial software (e.g. Ridom SeqSphere+ Software, Ridom GmbH, Münster, Germany) solutions available for data analysis.

8.10 Quality control

Quality control of DNA fingerprinting is of the utmost importance. On all occasions, first-line controls should include strains with a known DNA fingerprint. In the case of spoligotyping, DNA of H37Rv and P3 should be included in each test to assess the performance of each of the 43 spacer oligonucleotide probes present on the blot. In MIRU-VNTR typing, a strain with a known typing profile should be included. In RFLP typing, a particular strain with a wide range of bands should be used in each test to check the normalisation [60].

A second-line control procedure is also advised and should include the blinded exchange of a set of DNA samples with another laboratory twice a year to test the reproducibility. As a third-line of control, a blinded set of DNA samples supplied by an international organisation to multiple institutes should be analysed to test proficiency in the given procedure [60].

For NGS, ideally, all steps of the workflow, from DNA extraction to sequencing, data analysis and reporting, should be standardised and well documented, and an external quality assessment programme should be in place to ensure the generated data meet international standards [24]. Since 2017, an EQA scheme for MTB WGS has been implemented within the ERLTB-Network to allow comparison of performance and results among different laboratories, to provide objective evidence of testing quality, and to identify areas for improvement and training needs [63].

References

1. Martínez M, García de Viedma D, Alonso M, Andrés S, Bouza E, Cabezas T, et al. Impact of laboratory cross-contamination on molecular epidemiology studies of tuberculosis. *J Clin Microbiol.* 2006 Aug;44(8):2967-9.
2. Martín A, Herranz M, Lirola MM, Fernández RF, Bouza E, García de Viedma D, et al. Optimized molecular resolution of cross-contamination alerts in clinical mycobacteriology laboratories. *BMC Microbiol.* 2008 Feb 14;8:30.
3. Barnes PF, Cave MD. Molecular epidemiology of tuberculosis. *N Engl J Med.* 2003 Sep 18;349(12):1149-56.
4. Bryant JM, Harris SR, Parkhill J, Dawson R, Diacon AH, van Helden P, et al. Whole-genome sequencing to establish relapse or re-infection with *Mycobacterium tuberculosis*: a retrospective observational study. *Lancet Respir Med.* 2013 Dec;1(10):786-92.
5. Boer AS, Borgdorff MW, de Haas PE, Nagelkerke NJ, van Embden JD, van Soolingen D. Analysis of rate of change of IS6110 RFLP patterns of *Mycobacterium tuberculosis* based on serial patient isolates. *J Infect Dis.* 1999 Oct;180(4):1238-44.
6. Van Soolingen D. Molecular epidemiology of tuberculosis and other mycobacterial infections: main methodologies and achievements. *J Intern Med.* 2001 Jan;249(1):1-26.
7. Gori A, Esposti AD, Bandera A, Mezzetti M, Sola C, Marchetti G, et al. Comparison between spoligotyping and IS6110 restriction fragment length polymorphisms in molecular genotyping analysis of *Mycobacterium tuberculosis* strains. *Mol Cell Probes.* 2005 Aug;19(4):236-44.
8. Kremer K, Arnold C, Cataldi A, Gutiérrez MC, Haas WH, Panaiotov S, et al. Discriminatory power and reproducibility of novel DNA typing methods for *Mycobacterium tuberculosis* complex strains. *J Clin Microbiol.* 2005 Nov;43(11):5628-38.
9. Kremer K, Au BK, Yip PC, Skuce R, Supply P, Kam KM, et al. Use of variable-number tandem-repeat typing to differentiate *Mycobacterium tuberculosis* Beijing family isolates from Hong Kong and comparison with IS6110 restriction fragment length polymorphism typing and spoligotyping. *J Clin Microbiol.* 2005 Jan;43(1):314-20.
10. Kamerbeek J, Schouls L, Kolk A, van Agterveld M, van Soolingen D, Kuijper S, et al. Simultaneous detection and strain differentiation of *Mycobacterium tuberculosis* for diagnosis and epidemiology. *J Clin Microbiol.* 1997 Apr;35(4):907-14.
11. Jong BC, Antonio M, Awine T, Ogungbemi K, de Jong YP, Gagneux S, et al. Use of spoligotyping and large sequence polymorphisms to study the population structure of the *Mycobacterium tuberculosis* complex in a cohort study of consecutive smear-positive tuberculosis cases in The Gambia. *J Clin Microbiol.* 2009 Apr;47(4):994-1001.
12. Embden JD, van Gorkom T, Kremer K, Jansen R, van Der Zeijst BA, Schouls LM. Genetic variation and evolutionary origin of the direct repeat locus of *Mycobacterium tuberculosis* complex bacteria. *J Bacteriol.* 2000 May;182(9):2393-401.
13. Embden JD, Cave MD, Crawford JT, Dale JW, Eisenach KD, Gicquel B, et al. Strain identification of *Mycobacterium tuberculosis* by DNA fingerprinting: recommendations for a standardized methodology. *J Clin Microbiol.* 1993 Feb;31(2):406-9.
14. Soolingen D, Qian L, de Haas PE, Douglas JT, Traore H, Portaels F, et al. Predominance of a single genotype of *Mycobacterium tuberculosis* in countries of east Asia. *J Clin Microbiol.* 1995 Dec;33(12):3234-8.
15. Kremer K, van Soolingen D, Frothingham R, Haas WH, Hermans PW, Martín C, et al. Comparison of methods based on different molecular epidemiological markers for typing of *Mycobacterium tuberculosis* complex strains: interlaboratory study of discriminatory power and reproducibility. *J Clin Microbiol.* 1999 Aug;37(8):2607-18.
16. Der Zanden AG, Kremer K, Schouls LM, Caimi K, Cataldi A, Hulleman A, et al. Improvement of differentiation and interpretability of spoligotyping for *Mycobacterium tuberculosis* complex isolates by introduction of new spacer oligonucleotides. *J Clin Microbiol.* 2002 Dec;40(12):4628-39.
17. Lindstedt BA. Multiple-locus variable number tandem repeats analysis for genetic fingerprinting of pathogenic bacteria. *Electrophoresis.* 2005 Jun;26(13):2567-82.
18. Supply P, Allix C, Lesjean S, Cardoso-Oelemann M, Rüsch-Gerdes S, Willery E, et al. Proposal for standardization of optimized mycobacterial interspersed repetitive unit-variable-number tandem repeat typing of *Mycobacterium tuberculosis*. *J Clin Microbiol.* 2006 Dec;44(12):4498-510.
19. Allix-Béguec C, Harmsen D, Weniger T, Supply P, Niemann S. Evaluation and strategy for use of MIRU-VNTRplus, a multifunctional database for online analysis of genotyping data and phylogenetic identification of *Mycobacterium tuberculosis* complex isolates. *J Clin Microbiol.* 2008 Aug;46(8):2692-9.
20. Köser CU, Bryant JM, Becq J, Török ME, Ellington MJ, Marti-Renom MA, et al. Whole-genome sequencing for rapid susceptibility testing of *M. tuberculosis*. *N Engl J Med.* 2013 Jul 18;369(3):290-2.

21. Walker TM, Ip CL, Harrell RH, Evans JT, Kapatai G, Dedicoat MJ, et al. Whole-genome sequencing to delineate *Mycobacterium tuberculosis* outbreaks: a retrospective observational study. *Lancet Infect Dis*. 2013 Feb;13(2):137-46.
22. Kohl TA, Harmsen D, Rothgänger J, Walker T, Diel R, Niemann S. Harmonized Genome Wide Typing of Tubercle Bacilli Using a Web-Based Gene-By-Gene Nomenclature System. *EBioMedicine*. 2018 Aug;34:131-38.
23. Jajou R, Kohl TA, Walker T, Norman A, Cirillo DM, Tagliani E, et al. Towards standardisation: comparison of five whole genome sequencing (WGS) analysis pipelines for detection of epidemiologically linked tuberculosis cases. *Euro Surveill*. 2019 Dec;24(50).
24. Meehan CJ, Goig GA, Kohl TA, Verboven L, Dippenaar A, Ezewudo M, et al. Whole genome sequencing of *Mycobacterium tuberculosis*: current standards and open issues. *Nat Rev Microbiol*. 2019 09;17(9):533-45.
25. Niemann S, Köser CU, Gagneux S, Plinke C, Homolka S, Bignell H, et al. Genomic diversity among drug sensitive and multidrug resistant isolates of *Mycobacterium tuberculosis* with identical DNA fingerprints. *PLoS One*. 2009 Oct 12;4(10):e7407.
26. Schürch AC, Kremer K, Daviena O, Kiers A, Boeree MJ, Siezen RJ, et al. High-resolution typing by integration of genome sequencing data in a large tuberculosis cluster. *J Clin Microbiol*. 2010 Sep;48(9):3403-6.
27. Gardy JL, Johnston JC, Ho Sui SJ, Cook VJ, Shah L, Brodtkin E, et al. Whole-genome sequencing and social-network analysis of a tuberculosis outbreak. *N Engl J Med*. 2011 Feb 24;364(8):730-9.
28. Roetzer A, Diel R, Kohl TA, Rückert C, Nübel U, Blom J, et al. Whole genome sequencing versus traditional genotyping for investigation of a *Mycobacterium tuberculosis* outbreak: a longitudinal molecular epidemiological study. *PLoS Med*. 2013;10(2):e1001387.
29. Bjorn-Mortensen K, Soborg B, Koch A, Ladefoged K, Merker M, Lillebaek T, et al. Tracing *Mycobacterium tuberculosis* transmission by whole genome sequencing in a high incidence setting: a retrospective population-based study in East Greenland. *Sci Rep*. 2016 09 12;6:33180.
30. Bjorn-Mortensen K, Lillebaek T, Koch A, Soborg B, Ladefoged K, Sørensen HC, et al. Extent of transmission captured by contact tracing in a tuberculosis high endemic setting. *Eur Respir J*. 2017 03;49(3).
31. Diel R, Kohl TA, Maurer FP, Merker M, Meywald Walter K, Hannemann J, et al. Accuracy of whole-genome sequencing to determine recent tuberculosis transmission: an 11-year population-based study in Hamburg, Germany. *Eur Respir J*. 2019 11;54(5).
32. Ford CB, Lin PL, Chase MR, Shah RR, Iartchouk O, Galagan J, et al. Use of whole genome sequencing to estimate the mutation rate of *Mycobacterium tuberculosis* during latent infection. *Nat Genet*. 2011 May;43(5):482-6.
33. Fiebig L, Kohl TA, Popovici O, Mühlendorf M, Indra A, Homorodean D, et al. A joint cross-border investigation of a cluster of multidrug-resistant tuberculosis in Austria, Romania and Germany in 2014 using classic, genotyping and whole genome sequencing methods: lessons learnt. *Euro Surveill*. 2017 Jan 12;22(2).
34. Meehan CJ, Moris P, Kohl TA, Pečerska J, Akter S, Merker M, et al. The relationship between transmission time and clustering methods in *Mycobacterium tuberculosis* epidemiology. *EBioMedicine*. 2018 Nov;37:410-16.
35. Merker M, Barbier M, Cox H, Rasigade JP, Feuerriegel S, Kohl TA, et al. Compensatory evolution drives multidrug-resistant tuberculosis in Central Asia. *Elife*. 2018 10 30;7.
36. Tagliani E, Anthony R, Kohl TA, de Neeling A, Nikolayevskyy V, Ködmön C, et al. Use of a whole genome sequencing-based approach for *Mycobacterium tuberculosis* surveillance in Europe in 2017-2019: an ECDC pilot study. *Eur Respir J*. 2021 01;57(1).
37. Walker TM, Choisy M, Dedicoat M, Drennan PG, Wyllie D, Yang-Turner F, et al. transmission in Birmingham, UK, 2009-19: An observational study. *Lancet Reg Health Eur*. 2022 Jun;17:100361.
38. World Health Organization (WHO). The use of next-generation sequencing technologies for the detection of mutations associated with drug resistance in *Mycobacterium tuberculosis* complex: technical guide. 2018 (WHO/CDS/TB/2018.19). Licence: CC BY-NC-SA3.0 IGO.
39. Beckert P, Sanchez-Padilla E, Merker M, Dreyer V, Kohl TA, Utpatel C, et al. MDR *M. tuberculosis* outbreak clone in Eswatini missed by Xpert has elevated bedaquiline resistance dated to the pre-treatment era. *Genome Med*. 2020 11 25;12(1):104.
40. Sun G, Luo T, Yang C, Dong X, Li J, Zhu Y, et al. Dynamic population changes in *Mycobacterium tuberculosis* during acquisition and fixation of drug resistance in patients. *J Infect Dis*. 2012 Dec 01;206(11):1724-33.
41. Merker M, Kohl TA, Roetzer A, Truebe L, Richter E, Rüschi-Gerdes S, et al. Whole genome sequencing reveals complex evolution patterns of multidrug-resistant *Mycobacterium tuberculosis* Beijing strains in patients. *PLoS One*. 2013;8(12):e82551.
42. Ezewudo M, Borens A, Chiner-Oms Á, Miotto P, Chindelevitch L, Starks AM, et al. Integrating standardized whole genome sequence analysis with a global *Mycobacterium tuberculosis* antibiotic resistance

- knowledgebase. Sci Rep. 2018 10 18;8(1):15382.
43. The Cryptic Consortium. A data compendium associating the genomes of 12,289 *Mycobacterium tuberculosis* isolates with quantitative resistance phenotypes to 13 antibiotics. PLoS Biol. 2022 08;20(8):e3001721.
 44. The Cryptic Consortium. Genome-wide association studies of global *Mycobacterium tuberculosis* resistance to 13 antimicrobials in 10,228 genomes identify new resistance mechanisms. PLoS Biol. 2022 08;20(8):e3001755.
 45. Walker TM, Miotto P, Köser CU, Fowler PW, Knaggs J, Iqbal Z, et al. The 2021 WHO catalogue of *Mycobacterium tuberculosis* complex mutations associated with drug resistance: A genotypic analysis. Lancet Microbe. 2022 04;3(4):e265-e73.
 46. Feuerriegel S, Kohl TA, Utpatel C, Andres S, Maurer FP, Heyckendorf J, et al. Rapid genomic first- and second-line drug resistance prediction from clinical. Eur Respir J. 2021 01;57(1).
 47. Jouet A, Gaudin C, Badalato N, Allix-Béguec C, Duthoy S, Ferré A, et al. Deep amplicon sequencing for culture-free prediction of susceptibility or resistance to 13 anti-tuberculous drugs. Eur Respir J. 2021 03;57(3).
 48. Pankhurst LJ, Del Ojo Elias C, Votintseva AA, Walker TM, Cole K, Davies J, et al. Rapid, comprehensive, and affordable mycobacterial diagnosis with whole-genome sequencing: a prospective study. Lancet Respir Med. 2016 Jan;4(1):49-58.
 49. Vogel M, Utpatel C, Corbett C, Kohl TA, Iskakova A, Ahmedov S, et al. Implementation of whole genome sequencing for tuberculosis diagnostics in a low-middle income, high MDR-TB burden country. Sci Rep. 2021 07 28;11(1):15333.
 50. Mears J, Vynnycky E, Lord J, Borgdorff MW, Cohen T, Crisp D, et al. The prospective evaluation of the TB strain typing service in England: a mixed methods study. Thorax. 2016 08;71(8):734-41.
 51. Kik SV, Verver S, van Soolingen D, de Haas PE, Cobelens FG, Kremer K, et al. Tuberculosis outbreaks predicted by characteristics of first patients in a DNA fingerprint cluster. Am J Respir Crit Care Med. 2008 Jul 01;178(1):96-104.
 52. Lambregts-van Weezenbeek CS, Sebek MM, van Gerven PJ, de Vries G, Verver S, Kalisvaart NA, et al. Tuberculosis contact investigation and DNA fingerprint surveillance in The Netherlands: 6 years' experience with nation-wide cluster feedback and cluster monitoring. Int J Tuberc Lung Dis. 2003 Dec;7(12 Suppl 3):S463-70.
 53. Vries G, van Hest RA, Burdo CC, van Soolingen D, Richardus JH. A *Mycobacterium tuberculosis* cluster demonstrating the use of genotyping in urban tuberculosis control. BMC Infect Dis. 2009 Sep 08;9:151.
 54. Borgdorff MW, Nagelkerke NJ, de Haas PE, van Soolingen D. Transmission of *Mycobacterium tuberculosis* depending on the age and sex of source cases. Am J Epidemiol. 2001 Nov 15;154(10):934-43.
 55. Verver S, Warren RM, Munch Z, Richardson M, van der Spuy GD, Borgdorff MW, et al. Proportion of tuberculosis transmission that takes place in households in a high-incidence area. Lancet. 2004 Jan 17;363(9404):212-4.
 56. Verver S, Warren RM, Munch Z, Vynnycky E, van Helden PD, Richardson M, et al. Transmission of tuberculosis in a high incidence urban community in South Africa. Int J Epidemiol. 2004 Apr;33(2):351-7.
 57. Verver S, Warren RM, Beyers N, Richardson M, van der Spuy GD, Borgdorff MW, et al. Rate of reinfection tuberculosis after successful treatment is higher than rate of new tuberculosis. Am J Respir Crit Care Med. 2005 Jun 15;171(12):1430-5.
 58. Merker M, Blin C, Mona S, Duforet-Frebourg N, Lecher S, Willery E, et al. Evolutionary history and global spread of the *Mycobacterium tuberculosis* Beijing lineage. Nat Genet. 2015 Mar;47(3):242-9.
 59. Walker TM, Merker M, Knoblauch AM, Helbling P, Schoch OD, van der Werf MJ, et al. A cluster of multidrug-resistant *Mycobacterium tuberculosis* among patients arriving in Europe from the Horn of Africa: a molecular epidemiological study. Lancet Infect Dis. 2018 04;18(4):431-40.
 60. Braden CR, Crawford JT, Schable BA. Quality assessment of *Mycobacterium tuberculosis* genotyping in a large laboratory network. Emerg Infect Dis. 2002 Nov;8(11):1210-5.
 61. de Beer JL, Ködmön C, van Ingen J, Supply P, van Soolingen D, 2010 GNfMSoT. Second worldwide proficiency study on variable number of tandem repeats typing of *Mycobacterium tuberculosis* complex. Int J Tuberc Lung Dis. 2014 May;18(5):594-600.
 62. Brudey K, Driscoll JR, Rigouts L, Prodinger WM, Gori A, Al-Hajj SA, et al. *Mycobacterium tuberculosis* complex genetic diversity: mining the fourth international spoligotyping database (SpolDB4) for classification, population genetics and epidemiology. BMC Microbiol. 2006 Mar 06;6:23.
 63. Anthony RM, Tagliani E, Nikolayevskyy V, de Zwaan R, Mulder A, Kamst M, Ködmön C, van der Werf MJ, Cirillo D, van Soolingen D; ERLTB-Net members. Experiences from 4 Years of Organization of an External Quality Assessment for *Mycobacterium tuberculosis* Whole-Genome Sequencing in the European Union/European Economic Area. Microbiol Spectr. 2023 Feb 14;11(1):e0224422. doi: 10.1128/spectrum.02244-22. Epub 2022 Dec 8. PMID: 36475728; PMCID: PMC9927412.

9 Use and validation of disinfectants for *Mycobacterium tuberculosis*

Thomas Pottage and Allan Bennett

Revised by Thomas Pottage and Allan Bennett (2015)

9.1 Liquid disinfection

There are two standard methods for the analysis of disinfectants against mycobacterial organisms including *Mycobacterium tuberculosis* (TB); they are the quantitative suspension and quantitative carrier test. These methods have been documented as industry standards: suspension testing EN 14348:2005 and carrier testing

EN 14563:2008. The principle of the suspension test is to determine the efficacy of a chemical disinfectant against mycobacterial organisms within a suspension at a given temperature and over a set period of time. The carrier test is used to determine the efficacy of a disinfectant against a dried solution of *Mycobacterium* on a glass slide over a set period and at a set temperature. The strains of *Mycobacterium* specified in both standards are *Mycobacterium avium* (ATCC 15769) and *Mycobacterium terrae* (ATCC 15755), with *M. terrae* specified as the surrogate for *M. tuberculosis*. These micro-organisms are specified due to their lack of pathogenicity and there seems to be no reason why the standards could not be adapted for use with TB strains, simply by replacing the surrogate organism with the desired TB strain. However, replacing the strains would mean that the test would not follow the standard method and could not be designated as such. The standard methods, using TB surrogates, are summarised in the following sections. For full details the standards can be obtained from the relevant national standards body.

This could not be stated as tested to the standard but to a method based closely on the standard, and would give more accurate TB disinfection results since the disinfectant would be tested on the TB strain that would be used in vitro.

9.1.1 Suspension test: EN 14348:2005

A test suspension of the mycobacterial agent(s) should be prepared to give a suspension concentration from 1.5×10^9 CFU/ml to 5.0×10^9 CFU/ml. This suspension should be used on the day it is prepared. To count the stock suspension, dilutions of 10^{-7} and 10^{-8} should be prepared and 1 ml of the dilutions should be distributed as 0.5 ml onto 2 MCO (Middlebrook and Cohn 7H10 medium with 10% OADC enrichment) agar plates. This process should be performed in duplicate. The plates should then be incubated at $37 \pm 1^\circ\text{C}$ for 21 days.

The disinfectant test solutions should be prepared at 1.25 times the required test concentration. This is because during testing, with the addition of the validation suspension (1 ml) and interfering substance (1 ml) to 8 ml of the disinfectant, the concentration will be diluted to 100% of the test concentration. A further two concentrations of the product should also be prepared for testing, with at least one of these concentrations being weaker than the active range concentration. The test product suspensions should be made up in hard water to the required concentration.

Test products which are supplied ready-prepared for application (e.g. pre-soaked wipes) can be used but it should be noted in the test report that the concentration during testing will be equal to 80% and that this is the highest concentration achievable. Further dilutions of these ready-to-use products should be made using distilled water instead of hard water.

Product test solutions should be prepared for each test and used within two hours of preparation.

The test should be performed under two different conditions relating to the loading of organic material. This clean solution is prepared by adding 0.3 g of bovine albumin fraction V to 100 ml of the diluent (Tryptone sodium chloride solution, 1 g Tryptone, 8.5 g sodium chloride in 1 000 ml water). The clean conditions will require the addition of 1 ml of a 3 g/l solution of Bovine albumin fraction V solution to 9 ml of the test solution and test product. This will give a final solution concentration of 0.3 g/l in the 10 ml test solution.

The dirty conditions are achieved by combining a solution of bovine albumin fraction V and high concentration sheep erythrocytes. The solution is produced by dissolving 3 g of bovine albumin fraction V in 97 ml of diluent to give a solution of 30 g/l. This is diluted 1 in 10 during the test to give a final solution of 3 g/l. At least 8 ml of fresh defibrinated sheep blood should be centrifuged at 800 g for 10 minutes. The supernatant should be discarded and the erythrocytes re-suspended in the diluent. This step should be repeated at least three times until the supernatant has no colour. The erythrocytes can then be re-suspended and 3 ml added to 97 ml of the bovine albumin solution. The solution can be kept for seven days at a temperature ranging from 2°C to 8°C .

The suspension test is performed by first pipetting 1 ml of the clean or dirty interfering solution into a sterile tube followed by 1 ml of the test suspension. This tube should then be placed in a water bath at the set temperature of

20°C for two minutes. After the two minutes, 8 ml of the test product should be added to the tube and the time started. The tube should be mixed at the beginning of the 60-minute test period and just before the end of the period.

After the 60-minute test period, a 1 ml sample of the test solution should be removed from the tube and pipetted into a fresh sterile tube containing 1 ml of water and 8 ml of validated neutraliser. Pre-validation tests should have been conducted to ensure that the neutraliser is capable of neutralising the test product and does not inhibit the growth of the test organism(s). The tube should be placed in a water bath at 20°C for five minutes.

After the neutralisation step, a 1 ml sample of the neutralised test suspension should be pipetted and distributed evenly between two MCO plates, in duplicate. A further 500 µl of the neutralised test suspension should then be taken and added to a tube containing 4.5 ml of the neutraliser. This will give a 10⁻¹ solution of the test suspension which should be diluted further to 10⁻³ using the neutraliser. A 1 ml sample should be taken from each of the dilution tubes and divided between two MCO plates. This should be done in duplicate, to give four plates with 500 µl of diluted test suspension on them. The plates should be incubated for 21 days at 37±1°C.

The procedures for the other concentrations of the test product should be performed at the same time.

9.1.2 Carrier Test: EN 14563:2008

The carrier test should be performed using either *M. avium* (ATCC 15769) and *M. terrae* (ATCC 15755) or only *M. terrae*.

A test suspension of the mycobacterial agent(s) should be prepared to give a suspension concentration from 1.5 x 10⁹ CFU/ml to 5.0 x 10⁹ CFU/ml. This suspension should be used on the day it is prepared. To counting the stock suspension, dilutions of 10⁻⁷ and 10⁻⁸ should be prepared and 1 ml of the dilutions should be distributed as 0.5 ml onto 2 MCO (Middlebrook and Cohn 7H10 medium with 10% OADC enrichment) agar plates. This process should be performed in duplicate. The plates should then be incubated at 37±1°C for 21 days.

The disinfectant test solutions should be prepared using hard water. Three preparations shall be prepared, one in the active concentration range and at least one below the active concentration range.

Test products which are supplied ready-prepared for application (e.g. pre-soaked wipes) can be used directly for the testing. Any further dilutions of these products should use water in the place of hard water.

The product test solutions should be prepared for each test and used within two hours of preparation.

The disinfectant should be tested under two different conditions, with clean and dirty solutions. The procedure for producing these solutions is mentioned previously in the suspension test method (Suspension Test: EN 14348:2005).

The carrier for the test should be a glass carrier which has been frosted on one side (dimensions 15 x 60 x 1 mm). The carrier should be cleaned with 70% ethanol, and then a 10 mm square marked on the frosted side. Finally it should be sterilised in a dry heat oven.

To inoculate the carrier 9 ml of the test suspension should be added to 1 ml of the interfering substance in a clean tube. The tube should be mixed and 50 µl should be pipetted into the inoculation square on the carrier and distributed evenly around the square using the pipette tip. The carrier should then be placed in an incubator at 36±1°C for a maximum of 60 minutes or until it is visibly dry. The drying time should be recorded in the report sheet.

The carrier test is performed by pipetting 10 ml of the test product solution into a screw cap tube (wide enough to accommodate the carrier slide). The tube should then be placed in a water bath at 20°C. The carriers should be placed into the tubes immediately after the drying process has finished, making sure the inoculation square is covered by the test product solution. The timer should be started immediately on immersion and the tube left for the 60-minute contact time.

After the 60-minute exposure period, the carrier should be transferred to a screw cap tube filled with 10 ml of neutraliser and 1 ml of glass beads (diameter from 0.25 mm to 0.5 mm). Place in a water bath at 20°C then mix for 15 seconds. The tube should then be left for a further four minutes 45 seconds, giving a total neutralisation time of five minutes. Pre-validation tests should have been conducted to ensure the neutraliser is capable of neutralising the test product and does not inhibit the growth of the test organism(s). The tube should be placed in a water bath at 20°C for five minutes.

After the neutralisation period 1 ml of the neutralised solution containing the re-suspended test organisms from the carrier should be removed and divided equally between two MCO plates. This process should be performed in duplicate. Remove a further 500 µl and transfer to a tube containing 4.5 ml of neutraliser. This will give a 10⁻¹ solution of the test suspension which should be further diluted to 10⁻³ using the neutraliser.

Take a 1 ml sample from each of the dilution tubes and divide this between two MCO plates. This should be performed in duplicate to give four plates with 500 µl of diluted test suspension on them. The plates should be incubated for 21 days at 37±1°C.

The procedures for the other concentrations of the test product should be performed at the same time.

9.1.3 Choice of method to be used

The standard to be used depends on the application for which the disinfectant product is being used. For example, a surface disinfectant should preferably be tested using the carrier tests as that most closely matches this application. However, carrier tests are often thought to be more time consuming, even though there are less complications with the neutralisation step. The recommendation for using glass slides in the carrier test may raise concerns about potential for accidental abrasions in the laboratory and other materials may be considered. The specified 60-minute contact time will not always reflect the use of a product and it may be more realistic to reduce this to a shorter period, especially for the carrier test.

9.2 Gaseous disinfection

Gaseous decontamination has been used in microbiological laboratory facilities to decontaminate biological safety cabinets, equipment and the laboratory itself between experiments and before servicing [1-3]. It is often recommended for dealing with emergency situations such as uncontrolled releases of liquid culture in laboratories. Gaseous decontamination uses a vapourised chemical to contact, and in many cases condense onto, the exposed surfaces within the enclosure. Traditionally, gaseous lab decontamination has been undertaken using formaldehyde [4], where paraformaldehyde crystals are heated to sublimation or liquid formalin solution is boiled, both releasing formaldehyde vapour into the enclosure. This vapour then condenses onto the exposed surfaces and shows its disinfection properties by alkylating protein molecules when it binds to the primary amide and amino groups [2,5].

Although it is effective as a fumigant against *M. tuberculosis*, even in sputum [6] and against *M. bovis* [7], formaldehyde is a potential carcinogen [4], requires a long aeration period (for removal of the vapour from the enclosure, unless it can be neutralised, or external ventilation is available) and the paraformaldehyde residues left on the surfaces can be labour intensive to remove [5,8]. These drawbacks to formaldehyde have led to investigations into the use of alternative gaseous decontamination technologies for fumigation.

Of the candidates for a replacement fumigant in place of formaldehyde the best studied is perhaps hydrogen peroxide. The gaseous hydrogen peroxide systems were originally marketed for use in pharmaceutical clean room facilities, but their use has broadened to include microbiological laboratories [4], animal facilities [9], spacecraft assembly facilities [10] and in the hospital environment [11]. Hydrogen peroxide decontamination as a process has numerous advantages over formaldehyde fumigation. It leaves no residues, has better operator safety and is less damaging to the environment. Hydrogen peroxides work as an oxidising agent which produces hydroxyl radicals and superoxide anions [4] which can attack the cell's DNA and lipids, but being highly reactive the hydroxyl radicals will also react with other inorganic matter and materials [2].

Hydrogen peroxide is marketed for fumigations in three ways: Vaporised Hydrogen Peroxide (VHP), Hydrogen Peroxide Vapour (HPV) and aerosolised Hydrogen Peroxide (aHP). Hydrogen peroxide plasma sterilisation, which introduces vaporised hydrogen peroxide in a small vacuum chamber where the contaminated equipment is placed, has been shown to be effective for the decontamination of contaminated instruments, such as bronchoscopes [12].

9.2.1 Vaporised hydrogen peroxide and hydrogen peroxide vapour

Gaseous hydrogen peroxide is produced by heating and vaporising liquid hydrogen peroxide. Liquid hydrogen peroxide solutions have already been shown to be an effective decontaminant against TB [13,14]. Two of the more established companies have different approaches for the use of the vaporised hydrogen peroxide: Steris' generators use VHP and Bioquell's HPV.

The major differentiating factor between the two systems is the presence of microcondensation on the surfaces of the enclosure being fumigated. Steris' VHP technology dehumidifies the air within the enclosure prior to injection of VHP. This decreases the dew point in the enclosure and allows VHP to be injected without forming condensation on the surfaces, meaning although VHP is injected the system is designated 'dry'. The HPV technology designed by Bioquell operates in a similar fashion to formaldehyde fumigation, where HPV is injected into an enclosure above the dew point to allow for the formation of microcondensation on the surfaces. The microcondensate is a microscopic layer of hydrogen peroxide approximately 2–6 µm in thickness. Table 18 below describes more differences between the two technologies.

Table 18. Differences between the two major gaseous hydrogen peroxide technologies, Steris VHP and Bioquell HPV

Parameter	Steris	Bioquell
Description	Vaporised hydrogen peroxide	Hydrogen peroxide vapour
Condensation formed?	No	Yes
Requires dehumidification of enclosure?	Yes	No
Period of hydrogen peroxide injection	Continuous through exposure phase	One injection prior to decontamination phase
Volume of hydrogen peroxide needed	Large	Small
Generator located internally or externally in relation to enclosure	External	Internal or external (dependent on generator chosen)
Remote activation and monitoring	Yes (laptop needed)	Yes (control unit supplied extra)

Both VHP and HPV technologies have been shown to be efficacious against a wide range of bacteria, viruses and prions [2,9,11,15-19], often in company sponsored trials. Gaseous hydrogen peroxide has also been shown to be effective at killing TB within a biological safety cabinet and high-level containment laboratories [4,20]. The concentration of TB used by Hall on each indicator was approximately 10³ cells, this is low in comparison with the 10⁶ *G. stearothermophilus* spores on each of the other biological indicators. It was argued that the lower number of cells was more likely to equate to what would be remaining in a laboratory spillage after initial cleaning procedures were followed [20]. Kahnert's investigation found that even if a higher concentration of TB cells were dried onto biological indicators (ranging from 8.0x10⁴ to 2.3x10⁶ CFU), no organisms were recoverable after VHP exposure [4].

9.2.2 Dry mist hydrogen peroxide

Another way of aerosolising hydrogen peroxide within an enclosure for fumigation is to use an aerosolised hydrogen peroxide generator. An example of the generator, Glosair 400, is produced by Advanced Sterilisation Products. The aHP fumigation technique has been demonstrated to be effective against methicillin-resistant *Staphylococcus aureus*, *Acinetobacter baumannii*, *Clostridium difficile* and TB [21-24]. A comparison between aHP and 0.5% sodium hypochlorite solution was made by Barbut, which found the aHP more effective in killing *C. difficile* spores [22]. The aHP technology has also been successfully demonstrated against TB that had been dried onto stainless steel carriers (varying concentrations from 5x10⁵ to 5x10⁶ CFU/ml) and placed around a biosafety level 3 laboratory [25]. In Grare's study 5% hydrogen peroxide was used with a 60-minute exposure period to kill TB, whereas a study performed by Andersen under similar conditions demonstrated that the TB was not killed after aHP exposure [26]. It was hypothesised that the difference in results might be due to the preparation of the TB indicators. In Andersen's study, TB was dried from a saline solution whereas in Grare's experiments TB was dried from a distilled water solution which might have weakened the cell membrane, making it more susceptible to aHP decontamination [25,26].

9.2.3 Plasma hydrogen peroxide

A technology which can be employed to decontaminate smaller instruments rather than entire rooms or laboratories is hydrogen peroxide plasma sterilisation. The decontamination process uses a small vacuum chamber which is filled with vaporised hydrogen peroxide. After the vapour has diffused in the chamber, electromagnetic radiation is introduced to break the hydrogen peroxide molecules apart, inducing a plasma state and producing hydroxyl reactive species. This technology has been shown to be effective for sterilising bronchoscopes that had been contaminated with TB and initially decontaminated in a washer/disinfector, compared to bronchoscopes that had only been cleaned using a standard washer/disinfector cycle [12].

9.2.4 Use of gaseous disinfection in accident scenarios

Spillage of pathogenic microorganisms in a laboratory outside primary containment equipment should be an extremely rare event and should be prevented by employing the proper procedures and practices. The use of glass should be discouraged and samples should be contained when removed from primary containment using transport containers or bagging solutions. However, there may be occasions where these precautions are impractical [25].

The reaction to a spill of TB in a laboratory will depend on many factors, including the sample type (diagnostic specimen/positive, MDR TB, titre if known, staff exposed, location, etc.) and so any recommendation is based on a local risk assessment. However, the following course of events will occur:

- An aerosol will be generated which will be gradually removed by deposition or dilution.
- There will be uncontained liquid on the laboratory floor, localised in a pool where the container lands, and in the form of splashes and deposited aerosols which will be widely dispersed on the laboratory floor and potentially on other surfaces.
- Laboratory staff exposed to the spillage should leave the location, remove contaminated garments and wash any exposed areas of skin immediately. The laboratory should not be entered until any aerosol has been removed. The time allowed should be based on information about the sample volume, titre and room ventilation rate.
- There are three ways that the spill can be decontaminated.
- Immediate gaseous disinfection, preferably using a remote system (formaldehyde or hydrogen peroxide). The advantage of this system is that no operator is exposed by re-entering the area. However, the disadvantage is that the gaseous disinfectant may not penetrate into the highest concentration material of the spill. This area should be subjected to a final surface disinfection stage by an experienced laboratory worker wearing appropriate PPE before the laboratory is re-opened.
- After a suitable period of time an experienced laboratory worker wearing appropriate PPE enters the laboratory and decontaminates the spill site before setting off the gaseous decontamination. The laboratory can then be entered directly following the gaseous disinfection. The disadvantage of this approach is the exposure of the worker entering the laboratory.
- Surface disinfection alone could be undertaken by a worker in PPE including RPE. The disadvantages of this approach are that not all contaminated surfaces may be dealt with and the worker will be exposed.

Once again, the approach taken should be based upon a risk assessment carried out by experienced members of laboratory staff with biosafety expertise. It is preferable to have a risk assessment framework in place for such an eventuality.

References

1. Lach VH. A study of conventional formaldehyde fumigation methods. *Journal of Applied Bacteriology* 1990; 68:471-477.
2. Block S. *Disinfection, Sterilization and Preservation*. Fifth edition: Lippincott Williams & Wilkins 2001.
3. Luftman H, Regitis M. *B. atrophaeus* and *G. stearothermophilus* Biological Indicators for Chlorine Dioxide Gas Decontamination. *Applied Biosafety* 2008;13:143-157.
4. Kahnert A, Seiler P, Stein M, et al. Decontamination with vaporized hydrogen peroxide is effective against *Mycobacterium tuberculosis*. *Letters in Applied Microbiology* 2005;40:448-452.
5. Cheney JE, Collins CH. Formaldehyde disinfection in laboratories: limitations and hazards. *British Journal of Biochemical Science* 1995;52:195-201.
6. Bensted HJ, Beveridge WIB, Downie AW, et al. eds. *Disinfection of Fabrics with Gaseous Formaldehyde*, compiled by The Committee On Formaldehyde Disinfection 1958.
7. Munro K, Lanser J, Flower R. A comparative method to validate formaldehyde decontamination of biological safety cabinets. *Applied and Environmental Microbiology* 1999;65:873-876.
8. Ackland NR, Hinton MR, Denmeade KR. Controlled formaldehyde fumigation system. *Applied and Environmental Microbiology* 1980;39:480-487.
9. Krause J, McDonnell G, Riedesel H. Biodecontamination of animal rooms and heat-sensitive equipment with vaporized hydrogen peroxide. *Contemporary topics* 2001;40:18-21.
10. Chung S, Kern R, Koukol R, Barengoltz J, Cash H. Vapor hydrogen peroxide as alternative to dry heat microbial reduction. *Advances in Space Research* 2008;42:1150-1160.
11. Ray A, Perez F, Beltramini AM, et al. Use of vaporized hydrogen peroxide decontamination during an outbreak of multidrug-resistant *Acinetobacter baumannii* infection at a long-term acute care hospital. *Infect Control Hosp Epidemiol* 2010; 31: 1236-1241.
12. Bar W, Marquez de Bar G, Naumann A, Rusch-Gerdes S. Contamination of bronchoscopes with *Mycobacterium tuberculosis* and successful sterilization by low-temperature hydrogen peroxide plasma sterilization. *Am J Infect Control* 2001; 29: 306-311.
13. Sattar SA, Taylor YE, Paquette M, Rubino J. In-hospital evaluation of 7.5% hydrogen peroxide as a disinfectant for flexible endoscopes. *Can J Infect Control* 1996;11:51-54.
14. Dussurget O, Stewart G, Neyrolles O, et al. Role of *Mycobacterium tuberculosis* copper-zinc superoxide dismutase. *Infect Immun* 2001;69:529-533.
15. Heckert RA, Best M, Jordan LT, et al. Efficacy of vaporized hydrogen peroxide against exotic animal viruses. *Applied and Environmental Microbiology* 1997; 63: 3916-3918.
16. Rogers JV, Richter WR, Shaw MQ, Choi YW. Vapour-phase hydrogen peroxide inactivates *Yersinia pestis* dried on polymers, steel and glass surfaces. *Lett Appl Microbiol* 2008;47:279-285.
17. Klapes NA, Vesley D. Vapour-phase hydrogen peroxide as a surface decontaminant and sterilant. *Applied and Environmental Microbiology* 1990;56:503-506.
18. Kokubo M, Inoue T, Akers J. Resistance of common environmental spores of the genus *Bacillus* to vapor hydrogen peroxide. *PDA J Pharm Sci Technol* 1998;52:228-231.
19. Fichet G, Antloga K, Comoy E, Deslys JP, McDonnell G. Prion inactivation using a new gaseous hydrogen peroxide sterilisation process. *J Hosp Infect* 2007;67:278-286.
20. Hall L, Otter JA, Chewins J, Wengenack NL. Use of hydrogen peroxide vapor for deactivation of *Mycobacterium tuberculosis* in a biological safety cabinet and a room. *J Clin Microbiol* 2007;45:810-815.
21. Piskin N, Celebi G, Kulah C, Mengeloglu Z, Yumusak M. Activity of a dry mist-generated hydrogen peroxide disinfection system against methicillin-resistant *Staphylococcus aureus* and *Acinetobacter baumannii*. *Am J Infect Control* 2011.
22. Barbut F, Menuet D, Verachten M, Girou E. Comparison of the efficacy of a hydrogen peroxide dry-mist disinfection system and sodium hypochlorite solution for eradication of *Clostridium difficile* spores. *Infect Control Hosp Epidemiol* 2009;30:507-514.
23. Shapey S, Machin K, Levi K, Boswell TC. Activity of a dry mist hydrogen peroxide system against environmental *Clostridium difficile* contamination in elderly care wards. *J Hosp Infect* 2008;70:136-141.
24. Bartels MD, Kristoffersen K, Slotsbjerg T, et al. Environmental methicillin-resistant *Staphylococcus aureus* (MRSA) disinfection using dry-mist-generated hydrogen peroxide. *J Hosp Infect* 2008;70:35-41.
25. Grare M, Dailloux M, Simon L, Dimajo P, Laurain C. Efficacy of dry mist of hydrogen peroxide (DMHP) against *Mycobacterium tuberculosis* and use of DMHP for routine decontamination of biosafety level 3 laboratories. *J Clin Microbiol* 2008;46:2955-2958.
26. Andersen BM, Syversen G, Thoresen H, et al. Failure of dry mist of hydrogen peroxide 5% to kill *Mycobacterium tuberculosis*. *J Hosp Infect* 2010;76:80-83.

10 Information for physicians: laboratory diagnosis of TB

Dick van Soolingen, Vincent Jarlier, Francis Drobniewski

Revised by Francis Drobniewski with contributions from Dick van Soolingen and Vincent Jarlier (2015)

Revised by Daniela Maria Cirillo (2022)

10.1 Introduction

The TB laboratory provides crucial information for the diagnosis and management of people affected by TB disease.

Microbiologic data, based on culture or genomic tests, provide evidence to confirm clinical, radiological, epidemiological and pathology suspicions.

According to WHO guidelines for TB diagnosis, bacteriological confirmation should be attempted in all cases of pulmonary TB using WHO recommended diagnostics (WRDs) [1]. The same diagnostic tests could be used to provide bacteriological confirmation in cases of extrapulmonary TB (EPTB) when an appropriate specimen can be collected.

Therefore, optimal communication and understanding among the different clinical and laboratory specialists is of the utmost importance. The communication should include specification of the appropriateness of the different tests in the diagnostic algorithms, their negative and positive predictive values and how to translate the results into effective clinical management.

The whole process of collecting clinical specimens for the microbiological diagnosis is critical and each step may influence the result. Therefore, it is vital that collection and transport of diagnostic material should be optimal. The clinical material for laboratory analysis should always be accompanied by sufficient and correct patient information. In the case of presumptive pulmonary TB, the patient should be provided with the appropriate sputum pots and detailed instructions on how to produce the most suitable sputum for TB diagnostics. Only appropriate approaches for obtaining and transporting clinical specimens will result in the disease being successfully confirmed, which is also critical for surveillance and epidemiological purposes. The same rigorous process for collection and transport applies to EPTB specimens, often collected by invasive and not repeatable techniques. The material should be kept under well-defined temperature conditions and transported to the laboratory within defined time limits.

In the past 10 years several commercial molecular methods for detection of *M. tuberculosis* and identification of the drug-resistant variants have become the standard for the diagnosis of TB [1, 2]. Tests can be applied to a large variety of diagnostic specimens and can provide results in hours. With the implementation of next generation sequencing (NGS) technology coupled with target amplification, it is possible to identify markers of resistance to a large number of antimicrobials used in the therapeutic regimens directly from clinical specimens. Few commercial tests are available (see Chapter 6), and their applicability depends on the bacterial load present in the clinical specimen. Information on drug resistance to the main TB drugs becomes available in a few days from sample collection. The main limitations of those tests are linked to the bacillary load in the sample, to the lack of capacity to differentiate live from dead bacilli and to the suboptimal targets' inclusion in the tests.

Whole genome sequencing (WGS) from *M. tuberculosis* strains grown in culture has become the standard for epidemiological studies (see Chapter 8). Turn-around time is longer compared to targeted approaches, as it is linked to the availability of a positive culture. Data analysis is not fully automated, but many microbiology laboratories are now considering having a bioinformatic expert in the staff. Analysis of the sequencing data should be performed by standardised pipelines and a user-friendly report should be provided to the clinical team to optimise TB management (Figure 14). The report should include clear explanations on the determinants of drug resistance to the different drugs and how to manage the cases of discrepancies with phenotypic drug susceptibility testing (DST).

M. tuberculosis is a BSL3 pathogen, and each country has specific regulations on the safe transportation of these bacteria to referral laboratories. Communication on when and how a culture should be sent by a peripheral laboratory can help to reduce problems in transportation of this pathogen. Positive *M. tuberculosis* cultures can usually, but not always, reliably confirm a TB diagnosis. When a positive TB culture is reported from the laboratory from a sample collected from a person with very low suspicion of TB, it is very important to contact the laboratory to exclude clerical errors or laboratory cross-contamination. Cross-contamination rates (i.e. false-positives) of up to 3–5% of positive cultures have been reported. If misdiagnosis is suspected, communication between the laboratory and the physician is imperative to avoid unnecessary treatment. Often the presumptive TB diagnosis can be re-

considered by the physician in the case of false-positive cultures. Noting and discussing cross-contamination and other problems in the diagnosis of TB helps to improve the quality of this procedure.

This chapter aims to discuss how the information generated in the laboratory should be shared with clinicians and how to maximise the contribution of the laboratory in the diagnostic process.

All the information included in this chapter is based on the tests in use today. The field of diagnostics for TB is rapidly evolving after many years of stagnation. We expect that in few years different samples and tools for diagnosis of pulmonary TB will become available.

10.2 General considerations regarding the diagnosis of TB

General considerations are based on WHO recommendations and guidelines [1, 2] and publications listed at the end of the current chapter.

Diagnosis of TB and drug-resistant TB (DR-TB) should only be performed in accredited laboratories with appropriate workload to maintain proficiency for all the tests offered. WHO recommends a molecular test (among the WRDs) to be performed on a respiratory specimen as a first test for the diagnosis of pulmonary TB in adults able to produce sputum [2]. On the same specimen liquid culture using automated machines should be performed. Clinical material (such as sputum) for the culture-based diagnosis of TB and the initial drug susceptibility testing should be collected before the start of treatment.

For children and people not able to produce sputum, gastric aspirate or molecular detection on stools can be attempted [3, 4].

For EPTB, highly sensitive molecular tests should be attempted [1]. Liquid culture in MGIT remains the most sensitive technique.

The microbiologist should inform their clinical counterpart that the diagnostic accuracy of a test may vary with the specimen, so for EPTB it is important, in the presence of an initial negative molecular test, to rely on the clinical judgement for treatment initiation, while waiting for culture results. Liquid cultures are reported negative if no growth is observed at 6 weeks. TB meningitis requires special attention because of the low volume of cerebrospinal fluid (CSF) often submitted to the laboratory, therefore, rapid molecular tests such as Xpert Ultra should be prioritised in combination with liquid culture, while microscopy is usually negative also when cytospin is used.

Mycobacterial blood culture is not performed in all laboratories. It is important to inform the clinical counterpart that the yield may depend on the proper sample collection and transport. Specific blood culture bottles or isolator tubes should be provided in advance. For laboratory diagnosis multiple blood cultures are needed.

Whenever possible, a rapid molecular test to identify resistance to rifampicin and isoniazid should be offered. If, for cost reasons, it is not possible to test all presumptive TB cases, then the following groups should be prioritised: relapses, retreatments, contacts of MDR TB patients or isoniazid-resistant cases, and cases from high prevalence DR-TB countries. If mutations conferring resistance to rifampicin and/or isoniazid are detected, a molecular test to evaluate resistance to at least fluoroquinolones (FQs) should be performed before starting the therapy. On smear positive samples, targeted NGS on rifampicin-resistant cases can provide a rapid and more comprehensive drug resistance profile. Isoniazid-resistant cases should also be tested for fluoroquinolones resistance before starting the WHO-recommended treatment containing levofloxacin. Wherever the short 4 months regimen for drug susceptible TB is implemented [5, 6], the laboratory should provide information on molecular susceptibility to rifampicin (rifampicin remains reference for rifapentine), fluoroquinolones and isoniazid.

When culture is available, phenotypic tests can be performed. If the strain is a known rifampicin- or isoniazid-resistant strain, then a fluoroquinolone phenotypic test should be set up together with first line drugs. Whenever possible, for rifampicin-resistant cases second line drugs should be tested and priority to the drugs used for treatment should be given.

The following are additional tips to maximise the diagnostic yield:

- Molecular tests could be used for diagnosis of TB and drug resistance also after few days of treatment but are not suitable for treatment follow-up (unless development of resistance is suspected and, in this case, the molecular test could identify the appearance of drug resistance determinants not identified at baseline).
- After collection of the sputum in a suitable container, the quality of the sputum should be directly checked in terms of quality and quantity. A considerable part of the sputum should be true sputum and not saliva.
- Clinical material should be collected aseptically in sterile containers of the right size and shape to avoid contamination with non-tuberculous mycobacteria and other microorganisms. It should be noted that tap water contains multiple mycobacteria of different species and therefore should not be used in this procedure.
- All patient material should be collected, stored and transported according to the national guidance or standards, and in sufficient quantity. There is still a knowledge gap on the *ex vivo* survival of mycobacteria in clinical material. In one study on Ziehl-Neelsen (ZN)-positive sputa kept at 4°C, 60% of the mycobacteria

in the sputum appeared to be viable after four weeks, while at room temperature only 38% survived [7]. It is therefore advised to send pulmonary clinical material directly to the laboratory. If this is not possible, these should only be kept in the refrigerator for the minimum number of days. CSF should be processed immediately.

- Short transportation times, from specimen collection to arrival to the laboratory, can benefit diagnosis. Some extra-pulmonary fluids may even benefit from inoculation at the bedside into blood liquid culture to increase the probability of a positive *M. tuberculosis* diagnosis. However, if inoculated at the bedside, an additional sample should be collected for microscopy and great care should be made to avoid contamination by saprophytic flora.
- The yield of positive results will increase for some specimens if a higher amount of the material is provided (in case of CSF) or multiple samples are examined. In general, and especially for fluids with likely low concentration of bacteria, such as CSF, ascitic and pleural fluid, the largest possible volume should be collected and sent to the laboratory.
- All clinical material for TB diagnosis sent to a laboratory should be accompanied by a laboratory form including all the relevant information. Dedicated forms should be used, providing information such as the name of the patient, date of birth, gender, patient file number, probability of resistance to anti-tuberculosis drugs (i.e. previous history of TB, previous or current anti-tuberculosis treatment and country of birth), HIV status where possible, required diagnostic tests, date of sample collection, whether the sample was taken before or during treatment, and detailed information on the submitting physician, including telephone number.
- It is the responsibility of the sender to pack clinical samples appropriately. In most countries packaging is provided by the laboratories and generally consists of several layers of leak-proof material. The packaging should indicate that the material should only be opened inside an appropriate laboratory. *M. tuberculosis* cultures are a BSL3 microorganism, so special regulations apply. In principle, the biosafety regulations of directive 2000/54/EC [8] can be applied, but national authorities have also released individual regulations for the transportation of BSL3 microorganisms (see Chapter 1). It is recommended that the sender notifies the laboratory when the culture has been sent. Receiving laboratories should acknowledge receipt so that missing parcels can be traced.
- If *M. tuberculosis* culture is routinely performed at regional or peripheral laboratories, while additional laboratory procedures such as identification, drug susceptibility testing and genotyping are executed in larger laboratories and/or at National Reference laboratories (NRLs), it is of the utmost importance that positive cultures are sent to the centralised facility without delay.
- If the conditions of transport have compromised sterility and viability of *M. tuberculosis*, molecular diagnostics could still be applied. If samples are shipped for molecular tests only, inactivation before shipment could be considered. In this case samples can be shipped as 'non-infectious' reducing the shipping costs.
- Culture isolates can also be either inactivated or DNA can be extracted before shipment to reduce the cost of transport. In this case, the receiving laboratory should provide the preferred protocol for inactivation or DNA extraction.

10.3 Specific considerations regarding diagnosis of TB

10.3.1 Pulmonary material

Sputum (expectorated)

If there is a suspicion of pulmonary TB, >3 ml of early morning sputum should be collected in an appropriate sputum pot with a wide opening and a secure lid. This should be done on at least two consecutive days. As alternative, a second sample could be collected on spot if this is possible. The sputum should be freshly expectorated from the lung (rather than saliva) and the patient should be instructed on how to produce this material. The pooled collection of sputum over 24 hours should not be performed as the extended time of collection increases the chance of contamination by non-tuberculous mycobacteria and other bacterial microorganisms.

Sputum (induced)

If the patient is unable to produce sputum, sputum can be induced by supplying an aerosol of hypertonic saline solution (5%-10% NaCl) generated by a nebulizer. Such specimens may appear thin and watery and should be labeled 'induced sputum' so they will not be discarded by the laboratory as inadequate specimens. This procedure should be administered by trained personnel using appropriate respiratory protection in an isolation booth or in an area with appropriate environmental controls.

Bronchial lavage

The bronchial lavage (BAL) involves the instillation of sterile saline solution into a subsegment of the lung through the bronchoscope to wash the airways, followed by the suction and collection of the fluid sample. Although a routine procedure, it should be emphasised that carrying out a bronchoscopy in a patient suspected of TB can represent a risk to the person performing the procedure, and requires thorough disinfection of the bronchoscope (i.e. the procedure must be performed using appropriate safety standards). BAL should be centrifuged, and the pellet decontaminated in the laboratory before culture.

Gastric lavage

Investigation of gastric fluid is recommended in the diagnosis of pulmonary TB when examination of sputum or bronchial lavage fluid is not possible, for example in young children. Fasting gastric fluid should be collected after the administration of 20–30 ml of physiological saline in 5–10 ml of sodium carbonate (Na₂CO₃). The material should be transported to the laboratory within four hours or neutralised immediately at the site of collection. The investigation of gastric fluid can also be useful in the case of immunocompromised patients who are unable to provide sputum.

Nasopharyngeal aspirate

Nasopharyngeal aspiration (NPA) is another common method of obtaining clinical samples from children. Although it is less invasive than gastric lavage, NPA is still considered as an aerosol generating procedure⁶, and therefore, biosafety and infection prevention and control practices should be followed by the trained personnel. The procedure is performed by placing a flexible plastic catheter, connected to a suction pump, through the nostril into the posterior nasopharynx and by applying a gentle suction. The sample is collected into a sputum trap, and at least 2–5 mL of secretions should be collected.

Stool

Children with TB swallow sputum containing TB bacilli originating from the lungs, which then pass through the digestive tract, where they can be detected in stool samples. Stool is, therefore, regarded as a respiratory specimen for the diagnosis of TB.

Stool is a newly WHO recommended specimen for the diagnosis of pulmonary TB in children using Xpert MTB/RIF or Ultra [4]. It can be used as an alternative specimen, especially in situations when it is challenging to obtain adequate respiratory specimens for the diagnosis of pulmonary TB, such as in younger children. Testing stool may be more acceptable and feasible in certain settings, as it is less invasive than gastric or nasopharyngeal aspiration.

Testing a stool sample by Xpert MTB/RIF or Ultra requires a pre-processing step. Resources on the processing methods are widely available [9].

10.3.2 Extrapulmonary material

TB disease can occur in almost any anatomical site; thus, a variety of clinical specimens other than sputum (e.g. urine, cerebrospinal fluid, pleural fluid, pus, or biopsy specimens) may be submitted for examination when extrapulmonary TB disease is suspected. Procedures for the expeditious and recommended handling of the specimen must be in place or assured before the specialist performs an invasive procedure to obtain the specimen. Especially important is rapid transportation to the laboratory according to the laboratory's instructions. It is important to note that the portion of the specimen placed in formalin for histologic examination cannot be used for culture.

10.3.3 Pleural material

If pleural fluid is obtained, the chance of a positive culture can be improved by having increased volumes, which can then be concentrated. The largest volume possible should be taken and sent. However, recent studies have shown that the transport medium, place of inoculation and type of inoculation medium influence the yield of mycobacteria. Bedside inoculation in combination with a liquid *Mycobacterium spp.* medium appeared to be the best choice but at high risk of contamination. Alternatively, containers with heparin should be used to avoid clotting and trapping of mycobacteria [10]. Pleural fluid aspiration and pleural biopsy may increase diagnostic yield. A pleural biopsy is the recommended material for pleural TB.

10.3.4 Lymphadenitis material

For the diagnosis of tuberculous lymphadenitis, lymph node biopsy (ideal) and fine-needle aspiration are the first-choice diagnostic methods in both low-incidence and endemic countries [11, 12]. In the case of a negative fine needle aspiration, an excision biopsy should be considered, which often results in a higher chance of positive

⁶ Jackson T, Deibert D, Wyatt G, et al. Classification of aerosol-generating procedures: a rapid systematic review. *BMJ Open Res* 2020;7:e000730. doi:10.1136/bmjresp-2020-000730

microscopy for mycobacteria. For TB detection, the use of molecular WRDs is recommended. A fine-needle aspirate should be taken using a 19- or 21-gauge needle; the sample needs to be transported directly to the microbiological/pathological laboratory to prevent evaporation. It is important to inform both the pathologist and the microbiologist beforehand that the delicate clinical material is to be dealt with immediately.

Under no circumstances should the material for microbiological examination be placed in formalin (used for the histopathological specimen) as it will kill any TB bacteria present in the sample.

10.3.5 Peritoneal fluid

If tuberculous peritonitis is suspected, at least 5–10 ml ascitic fluid can be collected and sent to the laboratory or inoculated at the bedside in a liquid mycobacteria culture medium. However, in a review involving more than a thousand patients, a peritoneal biopsy appeared more sensitive [13, 14]. In general, sending the largest possible volume for centrifugation at the laboratory is ideal.

10.3.6 Urine

An early morning specimen should be collected, and the entire sample sent to the laboratory. The specimen should be refrigerated until transport. Multiple specimens over several days may be required to obtain a positive specimen. Due to contamination and deterioration, 24-hour urine specimens are not acceptable. Microscopy examination of urine sediment is not recommended due to the high risk for false positivity because of the presence of saprophyte mycobacteria of the genitourinary tract.

10.3.7 Blood

Blood cultures for mycobacteria should be performed using specific blood culture bottles provided by the laboratory. If the laboratory does not have the automated incubator, specimens should be collected in isolator tubes. The tubes should be stored at room temperature and transported to the laboratory on the same day of collection. Multiple cultures should be attempted to increase the diagnostic yield.

10.4 Information flow from microbiologist to physician and instructions regarding TB diagnosis

Physicians should provide basic patient information and specimen(s) to the laboratory that needs this information to guide its work, interpret the results and participate in TB surveys at local, regional, national and international levels. When laboratory results are reported to the physician, a basic level of information should always be provided to avoid mistakes and confusion, including date of specimen reception at the laboratory, test date, patient identifiers, results, and indications how to translate results into clinical management. Physicians should seek an unambiguous clarification of the results if needed. In the case of microscopic examination, an indication of the semi-quantitative result according to the WHO scale should be provided. If a peripheral or regional laboratory has already performed diagnostic tests, it is very helpful if these results are sent together with the culture to a centralised laboratory to avoid duplication or to allow confirmation.

For cultures, the quantitative results in terms of time to positivity (in days) for liquid medium are helpful (particularly where the samples have been sent to indicate treatment progress) and possibly the number of colonies on solid medium could be stated with an interpretation of the likely clinical relevance of this. A low number of colonies on a primary culture, unusual timings for positive cultures (e.g. a higher than usual positivity rate associated with inoculation on or around the same day, or a very short time to positivity in a smear-negative extra-pulmonary sample) may raise serious concerns of cross-contamination, and the laboratory needs to be aware of this. If suspected, positive cultures found on consecutive days can be subjected to molecular typing using WGS (see Chapter 8), and if the same sequencing profile is obtained, cross-contamination is highly likely.

In addition, the results of nucleic-acid amplification tests (NAATs) should be provided to the physician using appropriate wording and context and semi-quantitative results should always be reported. Overall, results validity depends on the use of inhibition/amplification controls, negative and positive controls, and the positive and negative predictive value. For example, when a NAAT is positive with a low semi-quantitative value, while smear microscopy is negative, it should be explained that the positive predictive value of this result is highly dependent on the prevalence of TB in the respective patient category. Sensitivity of new platforms has highly increased with the next generation of molecular tests now available in the market (see Chapter 6). Increasing the sensitivity for the paucibacillary smear negative samples has come at the cost of decreasing the specificity. Samples that are reported as Xpert Ultra 'trace' should be interpreted based on the clinical and epidemiological situation. People at high risk for serious TB consequences for underlying diseases, age, immunological status or known contacts of infectious TB cases should be started on treatment while culture results are pending. If no information on the molecular drug resistance pattern is available, then the treatment should be initiated based on the epidemiological information.

There has been substantial progress in the development of rapid diagnostic tests for both TB and drug resistance (see Chapter 6). These tests reduce delays in diagnosing and initiating TB treatment [15], and can be used to direct the therapy and the choice of anti-tuberculosis drugs. WHO and other international consortia are providing information on how to interpret different mutations in drug resistance associated genes [16]. The capacity to interpret genomic variants with high confidence is high for drugs such as rifampicin, isoniazid, pyrazinamide, fluoroquinolones, injectable agents and linezolid. However, it is always possible to encounter discrepancies between phenotypic and genotypic test results and it is understandable if this generates confusion. The role of the clinical microbiologist is to guide the correct results interpretation and to clearly explain why these discrepancies occur. The main reasons for genotypic/phenotypic discrepancies are: i) technical difficulties and errors in the performance of DST; ii) the presence of unknown mechanism conferring drug resistance; iii) mutation confers low level resistance and critical concentration is set too high; iv) mutation is outside the region targeted by the molecular assay; v) the presence of heteroresistance not detected by molecular methods; vi) molecular assay detect silent mutations; and vii) errors due to probe interaction/binding in LPA or other molecular assays.

Next generation sequencing is now becoming a diagnostic tool at the EU-NRL level. It can be performed as WGS on positive culture or as target NGS from diagnostic samples (containing at least 5 000–10 000 genomes per mL of sample) [17]. The difference among the two NGS-based strategies is shown in Table 19.

Table 19. Key differences between WGS and targeted NGS strategies

Whole genome sequencing	Targeted next generation sequencing
Culture-based	Test for selected targets on direct clinical specimens
Detection of the total genomic changes (loss of function mutations role)	High coverage per sample, increased sensitivity for mutation detection, mixed infections
High volume of data	Detection of heteroresistance at low frequencies
Assembly and analysis challenging	High number of samples per run, lower cost per sample compared to standard Sanger sequencing
Expensive for higher coverage data	
No standardised kit available	
EQA available	

Both allow to evaluate a large number of determinants and are highly valuable in supporting the management of multidrug-resistant (MDR), pre-extensively resistant (pre-XDR), or extensively resistant (XDR) TB cases.

In general, the presence of mutations or large deletions or insertions in genes involved in the pathways of drug activation should be considered with suspicion particularly when mutations develop during the therapy, are associated to smear and culture positivity, or with lack of radiological improvement. In this case, minimum inhibitory concentration (MIC) testing on broth microdilution and phenotypic DST using the recommended drug critical concentrations should be requested and promptly reported.

Finally, it is important to establish a clear communication with the clinical counterpart: clinicians should understand advantages and limitations of all the tests that the laboratory offers and be guided in the interpretation of the results.

Figure 14. Example of reporting form for NGS-based testing (drug resistance profile and cluster analysis)

Institute Logo		Laboratory Medicine Service Hospital Director: Unit: Head of the laboratory:			
Annex 1: Analysis of the mutations associated with drug resistance[§] (<i>M. tuberculosis</i>)					
Patient ID : 40254-18	Date of Birth:				
Protocol:	Annex to Report:				
Lineage: 4.9 (H37Rv-like)	Cluster: Isolate NOT in cluster*				
Coverage: 73.86					
*The reference database includes all isolates which underwent Whole Genome Sequencing (WGS) at the Emerging Bacterial Pathogens Unit- IRCCS San Raffaele – Milan, Italy.					
Pag. 1 / 2					
Drug	Region	Gene	Mutation (aminoac.)	Interpretation	Additional Information**
Rifampicin	Rv0667	<i>rpoB</i>	Ser450Leu	Resistant	
Isoniazid	Rv1483 Rv1908c	<i>inhA</i> <i>katG</i>	c-15t Ser315Thr	Resistant	
Ethambutol	Rv3795 Rv3794	<i>embB</i> <i>embA</i>	Asn296His c-16g	Resistant	
Pyrazinamid	Rv2043c Rv0006	<i>pncA</i> <i>gyrA</i>	Asp8Glu Glu21Gln Ser95Thr Gly247Ser Gly668Asp	Resistant	Lineage associated mutations
Fluoroquinolones (MXF; LFX; OFX)	Rv0005	<i>gyrB</i>	Arg446His	Indeterminate	Mutation observed in both susceptible and resistant strains: not sufficient evidence that this mutation is associated with resistance; phenotypic testing is recommended to confirm.
Amikacin	Rvnr01 Rv2416c	<i>rrs</i> <i>eis</i>	/	Susceptible	
Kanamycin	Rvnr01 Rv2416c	<i>rrs</i> <i>eis</i>	/	Susceptible	
Capreomycin	Rvnr01 Rv1694	<i>rrs</i> <i>tlyA</i>	/	Susceptible	Silent mutation;
Ethionamide	Rv3854 Rv3855 Rv1483	<i>ethA</i> <i>ethR</i> <i>inhA</i>	/	Resistant	
Bedaquiline	Rv1305 Rv0678	<i>atpE</i> /	/	Sensible	
Delamanid	Rv3261	<i>fdiA</i>	/	Sensible	
Mod. xxx xxx 001					

Institute Logo		Laboratory Medicine Service Hospital Director: Unit: Head of the laboratory:			
Annex 1: Analysis of the mutations associated with drug resistance[§] (<i>M. tuberculosis</i>)					
Patient ID : 40254-18	Date of Birth:				
Protocol:	Annex to Report:				
Lineage: 4.9 (H37Rv-like)	Cluster: Isolate NOT in cluster*				
Coverage: 73.86					
*The reference database includes all isolates which underwent Whole Genome Sequencing (WGS) at the Emerging Bacterial Pathogens Unit- IRCCS San Raffaele – Milan, Italy.					
Pag. 2 / 2					
	Rv3262	<i>fdiB</i>	/		
	Rv1173	<i>fdiC</i>	/		
	Rv0407	<i>fgd1</i>	Phe320Phe		Silent mutation;
	Rv3547	<i>ddn</i>	/		
	Rv0701	<i>rp1C</i>	/		
Linezolid	Rvnr02	<i>rrl</i>	/	Susceptible	
Clofazimine	Rv0678 Rv1979c	/	/	Susceptible	
** Mutations not detected; wild-type					
§ WGS Analysis Pipeline : MTBseq; Kohi TA, Utpatel C, Schluessener V, De Filippo MR, Beckert P, Cirillo DM, Niemann S. 2018. MTBseq: a comprehensive pipeline for whole genome sequence analysis of Mycobacterium tuberculosis complex isolates. PeerJ 6:e5895 DOI: 10.7717/peerj.5895					
** Any variation of the standard parameters applied in the MTBSeq pipeline analysis are reported in this section.					
* The absence of mutations in a specific genomic region (Rv) does not exclude the possibility of resistance for the specific drug.					
Date					
	Head of the laboratory: <i>Signature</i>				
Mod. xxx xxx 001					

Institute Logo		Laboratory Medicine Service Hospital Director: Unit: Head of the laboratory:	
Annex 2: Relatedness Analysis (Molecular Epidemiology)			
Patient ID: 40254-18 / 50283-18 / 40978-18	Date of birth:		
Protocol:	Annex to Report: NA		
Lineage: 4.9 (H37Rv-like)	(Lineage H37Rv-like)		
Coverage: 73.86 / 90.12 / 63.55	Cluster: Isolates NOT in cluster*		
*The reference database includes all isolates which underwent Whole Genome Sequencing (WGS) at the Emerging Bacterial Pathogens Unit- IRCCS San Raffaele – Milan, Italy.			
Pag. 1 / 1			
The genomic analysis (WGS) has been performed using the Illumina MiniSeq platform.			
The epidemiologic analysis, performed by "R-studio package POPPR**" for the phylogenetic tree construction and the MTBseq** pipeline for the Single Nucleotide Polymorphisms (SNPs) analysis, has shown that the isolates 40241-18 / 40243-18 / 40059 are not part of a recent transmission chain having between them a SNPs distance > 6 as reported in the distant matrix below.			
	40254-18	50283-18	40978-18
40254-18	0		
50283-18	29	0	
40978-18	26	9	0
**Genetic Analysis of Populations with Mixed Reproduction Ver 2.8.1			
**Kohi TA, Utpatel C, Schluessener V, De Filippo MR, Beckert P, Cirillo DM, Niemann S. 2018. MTBseq: a comprehensive pipeline for whole genome sequence analysis of Mycobacterium tuberculosis complex isolates. PeerJ 6:e5895 DOI: 10.7717/peerj.5895			
Date			
	Head of the laboratory: <i>Signature</i>		

References

1. World Health Organization (WHO). WHO consolidated guidelines on tuberculosis. Module 3: diagnosis - rapid diagnostics for tuberculosis detection, 2021 update. ; 2021.
2. World Health Organization (WHO). WHO operational handbook on tuberculosis. Module 3: diagnosis - rapid diagnostics for tuberculosis detection, 2021 update. Licence: CC BY-NC-SA 3.0 IGO.
3. World Health Organization (WHO). WHO consolidated guidelines on tuberculosis. Module 5: management of tuberculosis in children and adolescents. Licence: CC BY-NC-SA 3.0 IGO.
4. World Health Organization (WHO). WHO operational handbook on tuberculosis. Module 5: management of tuberculosis in children and adolescents. Licence: CC BY-NC-SA 3.0 IGO.
5. World Health Organization (WHO). Treatment of drug-susceptible tuberculosis: rapid communication. June 2021.
6. World Health Organization (WHO). WHO consolidated guidelines on tuberculosis. Module 4: treatment - drug-susceptible tuberculosis treatment. Licence: CC BY-NC-SA 3.0 IGO.
7. Banda HT, Harries AD, Boeree MJ, Nyirenda TE, Banerjee A, Salaniponi FM. Viability of stored sputum specimens for smear microscopy and culture. *Int J Tuberc Lung Dis.* 2000 Mar;4(3):272-4.
8. Directive 2000/54/EC of the European Parliament and of the Council of 18 September 2000 on the protection of workers from risks related to exposure to biological agents at work (seventh individual directive within the meaning of Article 16(1) of Directive 89/391/EEC). Available at: <https://eur-lex.europa.eu/legal-content/EN/TXT/?uri=CELEX%3A32000L0054>
9. Global Laboratory Initiative World Health Organization (WHO). Practical manual of processing stool samples for diagnosis of childhood TB. Licence: CC BY-NC-SA 3.0 IGO. Available at: <https://www.who.int/publications/i/item/9789240042650>
10. Cheng AF, Tai VH, Li MS, Chan CH, Wong CF, Yew WW, et al. Improved recovery of *Mycobacterium tuberculosis* from pleural aspirates: bedside inoculation, heparinized containers and liquid culture media. *Scand J Infect Dis.* 1999;31(5):485-7.
11. Bekedam HJ, Boeree M, Kamenya A, Liomba G, Ngwira B, Subramanyam VR, et al. Tuberculous lymphadenitis, a diagnostic problem in areas of high prevalence of HIV and tuberculosis. *Trans R Soc Trop Med Hyg.* 1997;91(3):294-7.
12. Prasoon D. Acid-fast bacilli in fine needle aspiration smears from tuberculous lymph nodes. Where to look for them. *Acta Cytol.* 2000;44(3):297-300.
13. Chow KM, Chow VC, Szeto CC. Indication for peritoneal biopsy in tuberculous peritonitis. *Am J Surg.* 2003 Jun;185(6):567-73.
14. Wu DC, Averbukh LD, Wu GY. Diagnostic and Therapeutic Strategies for Peritoneal Tuberculosis: A Review. *J Clin Transl Hepatol.* 2019 Jun 28;7(2):140-48.
15. Lee JH, Garg T, Lee J, McGrath S, Rosman L, Schumacher SG, et al. Impact of molecular diagnostic tests on diagnostic and treatment delays in tuberculosis: a systematic review and meta-analysis. *BMC Infectious Diseases.* 2022 2022/12/14;22(1):940.
16. World Health Organization (WHO). Catalogue of mutations in *Mycobacterium tuberculosis* complex and their association with drug resistance. Licence: CC BY-NC-SA 3.0 IGO.
17. Jouet A, Gaudin C, Badalato N, Allix-Béguet C, Duthoy S, Ferré A, et al. Deep amplicon sequencing for culture-free prediction of susceptibility or resistance to 13 anti-tuberculous drugs. *Eur Respir J.* 2021 03;57(3).

Annex 3. Network partners

This list, which was revised by Yen Holicka in 2022, includes both former and current contributors to the project.

Name of participant	Institution/country
Alexander Indra	AGES – Austrian Agency for Health and Food Safety (Central office), Vienna, Austria
Vanessa Mathys Predecessor: Maryse Fauville-Dufaux	Sciensano, Brussels, Belgium
Elizabeta Bachiiska	National Reference Laboratory of TB, National Centre of Infectious and Parasitic Diseases (NCIPD), Sofia, Bulgaria
Ljiljana Žmak; Mihaela Obrovac Predecessor: Vera Katalinić-Janković	Croatian National Mycobacterium Reference Laboratory, Croatian National Institute of Public Health (CNIPH), Zagreb, Croatia
Despo Pieridou	Microbiology Department (MPHS), Nicosia General Hospital, Nicosia, Cyprus
Věra Dvořáková Predecessors: Marta Havelková; Ilona Zemanova	National Reference Laboratory for Mycobacteria, National Institute of Public Health, Prague, Czechia
Troels Lillebæk; Erik Michael Rasmussen Predecessor: Vibeke Østergaard Thomsen	International Reference Laboratory of Mycobacteriology, Statens Serum Institut (SSI), Copenhagen, Denmark
Tiina Kummik; Kadri Klaos	University Hospital (TUH), Tartu, Estonia
Silja Mentula Hanna Soini Marjo Haanper Heikkinen Predecessor Merja Marjamäki	National Institute for Health and Welfare (THL), Finland
Jerome Robert Predecessor: Vincent Jarlier	NRC for Mycobacteria and Resistance to Anti-Tuberculous Mycobacteria, Bacteriology-Hygiene, Pitié-Salpêtrière Hospital, Paris, France
Emmanuelle Cambau	Service de Mycobactériologie spécialisée et de référence Tour Bichat /Rez de chaussée, Hôpital Bichat, DMU Biogem Laboratoire associé au CNR des Mycobactéries et Résistance des Mycobactéries aux Antituberculeux (CNR-MyRMA), France
Stefan Niemann Predecessors: Florian Maurer; Sabine Rüscher-Gerdes	National Reference Laboratory for Mycobacteria, Forschungszentrum Borstel, Borstel, Germany
Dimitrios Papaventsis	National Reference Laboratory for Mycobacteria (NRLM), Sotiria Chest Diseases Hospital, Athens, Greece
Ágnes Bakos; Lilla Katalin Lőrinczi Predecessors: Nóra Szabó; Anikó Guba	Korányi National Institute for Pulmonology, Budapest, Hungary
Hauksdóttir Gudrun Svanborg Predecessors: Guðrún Sigmundsdóttir; Ingibjörg Hilmarsdóttir	Department of Microbiology, Landspítali University Hospital, Reykjavik, Iceland
Margaret Fitzgibbons Predecessor: Noel Gibbons	Irish Mycobacteria Reference Laboratory (IMRL), Microbiology Department, Central Pathology Laboratory, St. James's Hospital, Dublin, Ireland
Sarah Jackson Thomas Rogers	Health Protection Surveillance Centre, Ireland St James Hospital, Ireland

Name of participant	Institution/country
Federico Giannoni Predecessor: Lanfranco Fattorini	Istituto Superiore di Sanità (ISS), Rome, Italy
Daniela Maria Cirillo	San Raffaele Scientific Institute, Milan, Italy
Esther Walser-Domjan Predecessor: Sabine Erne	Liechtenstein
Laima Vasiliauskaite Birutė Nakčerienė Predecessor: Edita Pimkina	Vilnius University Hospital Santaros Klinikos, Vilnius, Lithuania
Monique Perrin Predecessor: Paul Reichert	Laboratoire National de Santé (LNS), Luxembourg
Anabel Darmanin Predecessors: Julie Haider; Karl Galea	Mater Dei Hospital, Malta
Dick van Soelingen	National Institute for Public Health and the Environment (RIVM), Bilthoven, the Netherlands
Anne Torun Mengshoel Vegard Eldholm Predecessor: Turid Mannsåker	National Reference Laboratory for Mycobacteria, Norwegian Institute of Public Health (NIPH), Division of Infectious Disease Control, Department of Bacteriology and Immunology, Oslo, Norway
Ewa Augustynowicz-Kopeć Predecessor: Zofia Zwolska	Microbiology Department in National Tuberculosis and Lung Diseases Research Institute. National Reference TB Laboratory, Warsaw, Poland
Isabel Carvalho Predecessors: Anabela Santos Silva; Anabela Medo Miranda	Direcção-Geral da Saúde, Portugal
Rita Macedo; Jorge Machado Predecessors: Maria João Simões; Susana David	Instituto Nacional de Saúde 'Dr. Ricardo Jorge', Departamento de Doenças Infecciosas, Laboratório Nacional de Referência das Infecções, Respiratórias para Micobactérias, Lisbon, Portugal
Roxana Coriu Predecessors: Daniela Homorodean; Ionela Muteanu	Marius Nasta Institute of Pulmonology, Romania
Igor Porvaznik Predecessor: Juraj Trenkler, Monika Poľanová	National Institute for Tuberculosis, Lung Diseases and Thorax Surgery, National Register for Tuberculosis, Vyšné Hágy, Slovakia
Manca Žolnir-Dovc	National Reference Laboratory for Mycobacteria, University Clinic of Respiratory and Allergic Diseases, Golnik, Slovenia
Laura Herrera-Leon Predecessor: María Soledad Jiménez Pajares	Centro Nacional de Microbiología. Instituto de Salud Carlos III, Madrid, Spain
Sofia Samper	University of Zaragoza, Zaragoza, Spain
Ramona Groenheit Predecessor: Sven Hoffner	Public Health Agency of Sweden, Solna, Sweden
Marieke van der Werf Predecessor: Davide Manissero	ECDC, STI, Blood Borne Viruses and TB section, Stockholm, Sweden
Csaba Ködmön Predecessors: Alexandra Clarici; Amanda Ozin	ECDC, STI, Blood Borne Viruses and TB section, Stockholm, Sweden

European Centre for Disease Prevention and Control (ECDC)

Gustav III:s Boulevard 40
16973 Solna, Sweden

Tel. +46 858601000
ECDC.info@ecdc.europa.eu
www.ecdc.europa.eu

Follow ECDC on social media

-  Twitter: [@ECDC_EU](https://twitter.com/ECDC_EU)
-  Facebook: www.facebook.com/ECDC.EU
-  LinkedIn: www.linkedin.com/company/ecdc/



Publications Office
of the European Union